

# FP6 IST

## SEEFIRE

### South-East Europe Fibre Infrastructure for Research and Education



---

## Deliverable 2.1

### Dark Fibre Lighting Technologies

---

**Author(s):** Josef Vojtech (editor), Andras Kovacs, Janos Mohacsi, Jan Radil, Stanislav Sima, Chrysostomos Tziouvaras, Pavle Vuletic, Djordje Vulovic,

**Status –Version:** Final – p

**Date:** 15-11-2005

**Distribution - Type:** PU/CO – R/O

**Code:** SEEFIRE-Deliverable 2.1

**Abstract:** This deliverable presents the various approaches and technological options in terms of equipment for lighting dark fibre and creating lambdas, which are suitable for research and education communities in SEE countries in the short-medium term.

### The SEEFIRE Project

The SEEFIRE Project is a special support action co-funded by the FP6 IST programme of the European Commission. SEEFIRE builds on the success of previous activities and projects, including SEEREN, to support research and education networks in southeast Europe and will provide input for preparing the next-generation networks for research and education in the region. The 12-month project, which started on 1 March 2005, will:

- establish a benchmark of existing and potentially available optical fibre for NRENs in the region;
- make an analysis of the technical options available for the deployment of dark fibre and the management of optical transmission by NRENs in the region;
- report on economic aspects and regulations;
- disseminate information and increase awareness about dark-fibre deployment both at technical and policy-making levels.

The recent progress in technology for optical transmission at high speed has made the deployment of owned or leased fibre networks a reality for NRENs. SEEFIRE will make a first step in the direction of a cost-effective gigabit network in southeast Europe, connecting researchers and universities in the region with other research users in Europe and worldwide. In doing so, the project will contribute to reducing the digital divide that affects several countries in southeast Europe, due in part to past political and economic circumstances.

The SEEFIRE Consortium consists of:	
TERENA (coordinating contractor)	The Netherlands
GRNET	Greece
CESNET	Czech Republic
NIIF/HUNGARNET	Hungary
AMREJ	Serbia and Montenegro
DANTE	United Kingdom
RoEduNet	Romania
ISTF	Bulgaria
MARNet	FYROM
ASA	Albania
BIHARNET	Bosnia and Herzegovina

The SEEFIRE project is funded by the European Commission under the FP6 Information Society Technologies contract no. 15817. This document contains material, which is the copyright of certain SEEFIRE contractors and the EC, and may not be reproduced or copied without permission. The information herein does not express the opinion of the EC. The EC is not responsible for any use that might be made of data appearing herein. The SEEFIRE contractors do not warrant that the information contained herein is capable of use, or that use of the information is free from risk, and accept no liability for loss or damage suffered by any person using this information.

## Table of contents

<b>1. Executive Summary .....</b>	<b>7</b>
<b>2. Introduction.....</b>	<b>8</b>
<b>3. Fibre Types.....</b>	<b>10</b>
3.1. OPTICAL FIBRES BASICS .....	10
3.2. MULTI-MODE AND SINGLE-MODE FIBRES .....	11
3.3. OPTICAL FIBRE STANDARDS .....	12
3.4. OPTICAL FIBRE ADVANTAGES .....	14
<b>4. Utilization of Different Wavelengths for Signal Transmission.....</b>	<b>15</b>
4.1. SINGLE WAVELENGTH .....	16
4.2. MULTI WAVELENGTH .....	18
<b>5. Optical Signal Modulations.....</b>	<b>29</b>
5.1. MODULATION FORMATS .....	29
5.2. SIGNAL FORMATS .....	29
<b>6. Fibre Lighting.....</b>	<b>31</b>
6.1. AMPLIFICATION .....	31
6.2. CHROMATIC DISPERSION COMPENSATION .....	37
<b>7. Single and Multi Spans Configurations for Optical Transmission Systems.....</b>	<b>39</b>
7.1. SINGLE SPAN SOLUTIONS – NOTHING IN LINE (NIL) APPROACH.....	39
7.2. MULTI SPAN SOLUTIONS.....	41
<b>8. Pure Optical Networks .....</b>	<b>44</b>
8.1. OPTICAL ADD DROP MULTIPLEX (OADM) TECHNOLOGY .....	44
8.2. RECONFIGURABLE OPTICAL ADD DROP MULTIPLEX (ROADM) TECHNOLOGY .....	49
<b>9. Optical Measurement .....</b>	<b>51</b>
9.1. ATTENUATION .....	51
9.2. CHROMATIC DISPERSION AND POLARIZATION MODE DISPERSION.....	53
<b>10. Evaluation and Experiences.....</b>	<b>55</b>
10.1. GIGABIT PLUGGABLE TRANSCEIVERS .....	55
10.2. TEN GIGABIT PLUGGABLE TRANSCEIVERS (XFP, XENPACK) .....	62
10.3. THE REST OF TEN GIGABIT TRANSCEIVERS .....	68
10.4. BRIEF 10GBIT/S MSAS COMPARISON .....	71
<b>References.....</b>	<b>72</b>
<b>Acronyms.....</b>	<b>74</b>

## List of figures

Figure 1: Optical fibre cable [1]	10
Figure 2: Total internal reflection [1]	10
Figure 3: Multi-mode and single-mode fibres	11
Figure 4: Multi-mode fibre	11
Figure 5: Single-mode fibre	11
Figure 6: CD for G.652 fibre	12
Figure 7: Attenuation for G.652 fibre [5]	12
Figure 8: CD comparison for available fibre standards	13
Figure 9: Optical fibre generations and their attenuation	16
Figure 10: Attenuation of an optical fibre and remarkable transmission bands [source: Cisco Systems]	19
Figure 11: Converting a baseband optical signal to fit into a grid of DWDM channels	22
Figure 12: WDM multiplexer and demultiplexer	23
Figure 13: Fibre switching	23
Figure 14: Wavelength switching	24
Figure 15: Wavelength conversion	24
Figure 16: Optical Add Drop Multiplexer layout	25
Figure 17: G.694.2 wavelength grid	27
Figure 18: EDFA operation principle [11]	32
Figure 19: EDFA configuration	32
Figure 20: Raman amplifier principle (co-pumped version)	34
Figure 21: OAs operational wavelength ranges	35
Figure 22: Hybrid OA using EDFA and counter pumped Raman OA	36
Figure 23: Hybrid EDFA-Raman OA gain spectra comparison [9]	36
Figure 24: Fibre OA and hybrid system comparison	37
Figure 25: Four channels over 202 km NIL setup	40
Figure 26: Two 10GE channels over 202 km NIL setup	41
Figure 27: Single wavelength dual-channel OADM	45
Figure 28: 4-channel OADM	45
Figure 29: Point-to-point physical and logical topology	45
Figure 30: Devices and channels in point-to-point application	46
Figure 31: Bus physical and logical topology	46
Figure 32: Devices and channels in bus application	47
Figure 33: Protected hub-and-spoke physical and logical topology	47
Figure 34: Devices and channels in protected hub-and-spoke application	48
Figure 35: Ring physical and logical topology	48
Figure 36: Devices and channels in ring application	49
Figure 37: The Wavelength Blocker Architecture [6]	50

---

<i>Figure 38: Wavelength Selective Switch architecture [6]</i>	50
<i>Figure 39: Cut-back method</i>	52
<i>Figure 40: Insertion loss method with one reference module - <math>P_1</math> measurement</i>	52
<i>Figure 41: Insertion loss method with two references module - <math>P_1</math> measurement</i>	52
<i>Figure 42: Insertion loss method with three references module - <math>P_1</math> measurement</i>	52
<i>Figure 43: Insertion loss method – <math>P_2</math> measurement</i>	52
<i>Figure 44: XENPAK interface physical layout [21]</i>	63
<i>Figure 45: XFP interface physical layout</i>	65

## List of tables

<i>Table 1: Fibre standards comparison</i>	13
<i>Table 2: Single-mode transmission bands</i>	17
<i>Table 3: CWDM &amp; DWDM technologies comparison</i>	26
<i>Table 4: CESNET NIL results</i>	41
<i>Table 5: Cisco Systems, ONS 15454, Multi Span examples</i>	42
<i>Table 6: Marconi Corporation - Single Span examples</i>	42
<i>Table 7: Marconi Corporation - Multi Span examples</i>	42
<i>Table 8: Policy of GBIC vendors</i>	56
<i>Table 9: Cisco Systems GBICs</i>	56
<i>Table 10: Agilent GBICs</i>	57
<i>Table 11: Finisar GBICs</i>	58
<i>Table 12: Cisco GE SFPs</i>	59
<i>Table 13: Cisco SONET POS/ATM SFPs</i>	60
<i>Table 14: Agilent GE SFPs</i>	60
<i>Table 15: Finisar GE SFPs</i>	61
<i>Table 16: IEEE 802.3ae 10GE physical mediums</i>	63
<i>Table 17: Cisco XENPAKs</i>	64
<i>Table 18: Agilent XENPAKs</i>	64
<i>Table 19: Agilent XFPs</i>	65
<i>Table 20: Cisco XFPs</i>	66
<i>Table 21: Finisar XFPs</i>	66
<i>Table 22: MRV XFPs</i>	67
<i>Table 23: Finisar XPAKs</i>	69
<i>Table 24: Merge Optics XPAKs</i>	69
<i>Table 25: Cisco X2s</i>	70
<i>Table 26: Finisar X2s</i>	70
<i>Table 27: Merge Optics X2s</i>	71
<i>Table 28: 10 Gbit MSAs comparison</i>	71

# 1. Executive Summary

This deliverable provides practical information about technologies, which are essential for NRENs in the southeast European region willing to deploy their own or leased dark-fibre infrastructure. The deliverable presents the various approaches, technological options and available equipment for lighting dark fibre and creating lambdas. The authors have considerable experience in this area and have a good understanding of dark-fibre lighting needs in southeast European countries in the short-medium term.

D2.1 is the first technical deliverable of SEEFIRE to become publicly available. The document provides a background of fibre lighting technologies, which will also be input to a more practically oriented document, the deliverable D2.2 to be published before the end of 2005. Both documents together will provide input to a final strategic report about the possibilities to deploy cost-effective advanced transmission technology.

In general, the deliverable covers aspects of optical transmission systems, which are important for southeast European NRENs. It deals with basic possibilities of long-distance (metropolitan area and intercity) optical transmission and investigates different approaches, from the most simple ones, like single wavelength transmission (both in original and conventional optical bands) to more complex and modern ones, like wavelength multiplexing systems, including advanced Dense Wavelength Division Multiplexing (DWDM) but also cost-effective Coarse Wavelength Multiplexing (CWDM).

The deliverable also informs the reader about basic modern WDM systems topologies most often used in practise. Attention is given to all important system parameters affecting system performance and cost, like the fibre type, the way of dealing with attenuation (especially by optical amplifiers), dispersion compensation and so on. Other building blocks of modern optical networks like reconfigurable multiplexers and optical cross-connects are also described in the document. The Nothing in Line (NIL) approach, a well known network building system to avoid the usage of in-line amplifiers, is also addressed and compared with other, more conventional principles.

The deliverable also covers short description of basic important optical measurement and references to appropriate procedures. Pluggable transceivers represent a high-potential technology for NRENs in the region, because of the wide availability, affordability and consolidated experience by some NREN. Special attention is paid in the document to pluggable transceivers.

The information provided in this deliverable is meant to help NRENs who are moving or consider moving to own or lease optical fibre networks to understand the principles of transmission technology systems available now and in the short-medium term. The possible logical topologies and the major facts affecting system performance as well as cost are addressed in the document. Concerning long-distances transmission, the multi-spans systems are compared with NIL approach and its possibilities. The deliverable also offers overview of necessary optical measurement methods and procedures. The text contains a lot of references to other sources, which can be used to obtain further details, including reference to vendor's equipment and systems.

## 2. Introduction

The deliverable is structured into chapters describing fibre types, utilization of different wavelengths for signal transmission, optical signal modulations, fibre lighting, single and multi span configurations for optical transmission systems, pure optical networks, optical measurement of attenuation and dispersion, evaluation of pluggable transceivers including XFP and XENPACK and brief 10Gbit/s MSAs comparison.

The deliverable reflects the changing situation in research and education networks. Research and education networks in several parts of the world are not anymore limited by the telecom services offered by operators. The progress in technologies for optical transmission at high speed (10Gbit/s and more) and multi-wave parallel transmissions (for example 128x10Gbit/s) in recent years has made the deployment of owned or leased fibre networks a reality for an increasing number of NRENs in Europe, as well as Regional Optical Networks (RON) in the US, Canada and beyond. The last developments have made possible continent-wide leased fibre research and education networks such the National Lambda Rail in the US and GÉANT2 in Europe. Not all locations in these continents are available yet, but the network footprint is expanding rapidly.

Dark fibre use has contributed to increased independency of NRENs from the telecom services offered by operators. This independency entails that these services are used only if they are cost-effective compared to the leased dark fibre alternative.

Dark-fibre networks enable new research applications by providing national and international connections of university and research premises by means of fixed or scheduled wavelengths or light-paths (Layer1 or Layer2 services in addition to traditional IP service).

The availability of dark fibres, to various extents, for all the NRENs involved in the SEEFIRE project, would enable equal participation of SEE countries in the above applications. This would be beneficial for these countries as well as for the European research, because the scientific capacity of SEE would be technologically integrated into the wider European community.

Whereas the necessity of dark fibres (Layer0) for NRENs is evident now, the situation of dark-fibre lighting (Layer1) is not so clear and opinions are developing. Knowledge of computer hardware design and production indicates that network design should be based on multi-sourced building elements, if possible. The use of single-sourced building elements frequently leads to dependency on delivering company, or at least to decrease in profit coming from product deployment.

The legacy situation in network design and deployment is based on single-vendor environment, including the lighting equipment (Layer1), the switching equipment (Layer2) and the routing equipment (Layer3). As a result, there is a small number of dominant vendors of network equipment, which make it difficult for NRENs to negotiate good prices. Although in some case discounts of about 50% from list prices are possible for research networks, the dependency on a single vendor is still a very serious problem in step-wise network innovation. Innovations are limited by so-called “road maps” (timing) of vendor technical development, which can be too much delayed compared to equipment availability from other sources. These road maps are important for market position and the profit of producer, but NRENs form a relatively small market segment and have long-term rather than immediate influence on market requests. On the other hand, a single-vendor environment can be seen as a guarantee of network functionality and services availability and reliability.

Important changes in the legacy situation will result from the well-known requirement for end-to-end services, i.e. services that are not limited to one single network. This means that a multi-domain and multi-vendor environment will be used for service deployment in general, and equipment interoperability will be inevitable. After this expected global development, multi-vendor equipment in one network will be easy to use, too. But interoperability is not a sufficient condition for multi-sourcing, for example because it does not guarantee the possibility of equipment replacement by equipment of a different producer, in a given network position, saving all relevant functions and properties.

For the above mentioned reasons, extending of NRENs independence on vendors is crucial. Networks could be designed by top-down method, but certainly are built by bottom-up method (Layer0 first, then Layer1, etc.). It looks like this bottom-up paradigm has also a role in increasing independency. The first impact of independency in Layer0 (move from the telecom services offered by operators to dark fibre lease) will be on independency in Layer1 (lighting). Feasibility of such step is proved (for example by deployment of optical amplifiers by CESNET), but wide deployment is still needed. The risk of interoperability of equipment delivered by different vendors can be limited by using of network design and integration support by external



company (experienced for example by SWITCH, <http://www.ces.net/doc/seminars/20050516/pr/kugler.pdf>).

**Independence on vendors has also strong actual motivation in SEE countries: cost effectiveness.**

**Purpose of this deliverable is to collect information and describe experience, which is important for dark-fibre lighting in SEE countries in the next 2-4 years.** Short notes about principles and technical history of some technologies are also presented for readers comfort, whereas some lecture book or vendors documentation should be used for more details.

This deliverable is oriented to help understanding the dark-fibre lighting needs in SEE countries in 2-4 years. For the time after this period, description of topics such as for example DWDM L band, ULH transmission, OEO on chip, optical switching, optical path restoration and optical packets generation, transmission and recognition can be important for SEE research and educational networking.

The vendors and products mentioned in the deliverable text have been chosen only on the basis of author's personal experiences.

### 3. Fibre Types

This chapter provides a short overview on the physics behind optical fibre transmission and focuses on available optical fibre types. Special attention is given to available fibre standards established by ITU-T.

#### 3.1. Optical Fibres Basics

An optical fibre cable includes glass or plastic fibres that act as waveguides for the optical signal. In other words fibres have the ability to guide light along their axis.

Figure 1 shows a cut of an optical fibre cable. As shown, it consists of three layers:

- the core, which is the medium where the light passes through,
- the cladding, which prevents the light from being refracted outside the core,
- the jacket, which provides physical protection to the fibre.

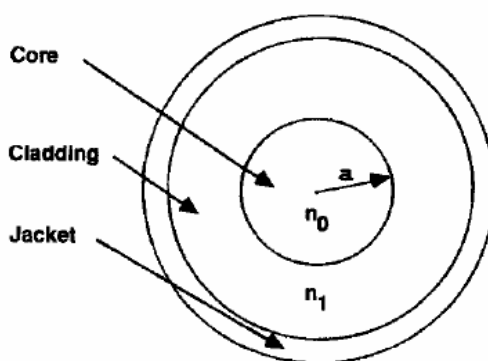


Figure 1: Optical fibre cable [1]

Transmission to optical fibres is based on the principle of Total Internal Reflection; with reference to Figure 1 and Figure 2, when

$$\theta_c \geq \sin^{-1}(n_1/n_0), \text{ where } n_0, n_1, \text{ are the refractive indices of the core and the cladding}$$

then the light is totally reflected in the core. On the other hand, if the Total Internal Reflection principle does not hold then both reflection and refraction occur. In this case, the light signal progressively attenuates and dies-off after certain distance.

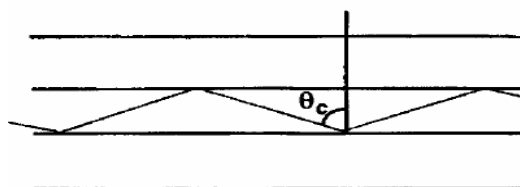


Figure 2: Total internal reflection [1]

### 3.2. Multi-mode and Single-mode Fibres

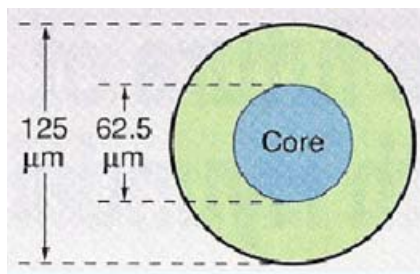
There are two major types of fibres depending on the propagation modes that an optical fibre supports: the multi-mode and single-mode fibres. For simplicity, in this chapter the expression “propagation modes” will be used to designate the rays of light that are transmitted within the optical fibre core. Elaboration on light propagation modes includes considering the dual nature of light and is out of the scope of this document.

As their names suggest, multi-mode fibres enable multiple modes of light to be simultaneously transmitted through the fibre core (refer to left side of Figure 3 for a multi-mode fibre carrying two propagation modes), while single-mode fibres enable only one mode of light (refer to right side of Figure 3).

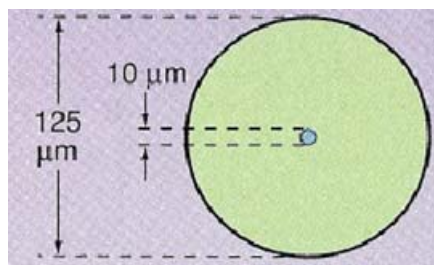


**Figure 3: Multi-mode and single-mode fibres**

Multi-mode fibres were the first to become commercially available. They have large diameter core so as to enable simultaneous transmission of multiple modes of light and they are typically used for short distance (a few kilometres) and low bandwidth (order of Gbit/s) applications. On the other hand, single-mode fibres have much smaller core diameter and are typically used for long-haul and metro networks. They can carry huge amounts of bandwidth by deploying DWDM technology (order of Tbit/s). Refer to Figure 4 and Figure 5 for cuts of a typical multi-mode and single-mode fibre respectively.



**Figure 4: Multi-mode fibre**



**Figure 5: Single-mode fibre**

### 3.3. Optical Fibre Standards

This section discusses the best-known and commercially deployed optical fibre ITU-T standards for single-mode fibres [4]. The reason for focusing on single-mode fibre standards is that this kind of fibres is used for long-haul networks and as such, they are of most importance for the SEEFIRE project.

#### 3.3.1. G.652 – Non Dispersion Shifted Fibre

ITU-T G.652 Non-Dispersion Shifted Fibre or standard single-mode fibre, was first introduced in mid-80s; it is the cheapest and the most widely deployed optical fibre type. It accounts for about 95% of worldwide fibre deployments. It was designed for use at the 1310nm (nanometre) wavelength region, in which Chromatic Dispersion (CD) is zero (refer to Figure 6).

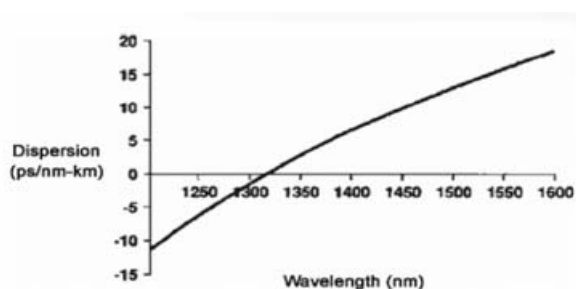


Figure 6: CD for G.652 fibre

Figure 7 depicts a typical attenuation graph for G.652 fibres. As it is shown, there’s an attenuation peak around the 1383nm region called “water peak region”; this is a wavelength region of approximately 80nm where fibre attenuation is impacted by bonds that hydrogen atoms form with oxygen in the glass.

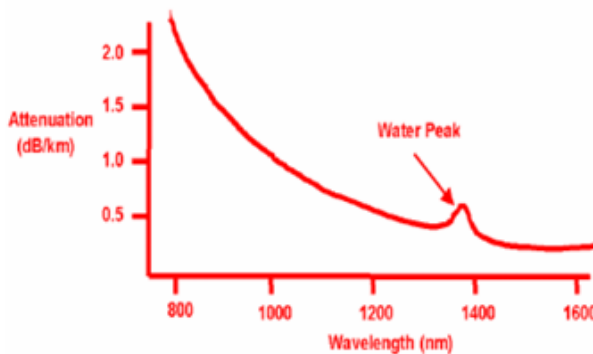


Figure 7: Attenuation for G.652 fibre [5]

#### 3.3.2. G.652c – Low Water Peak Non Dispersion Shifted Fibre

G.652 fibres are not optimized for WDM transmission and especially CWDM transmission because they present high attenuation values to the water peak region. Through improved fabrication G.652c fibres manage to drastically reduce the attenuation peak at the water peak region area and thus G.652.c fibres can be used for transmission across a much broader range of wavelengths.

### 3.3.3. G.653- Dispersion Shifted Fibre

ITU-T G.653 – Dispersion Shifted Fibre is designed for use in the 1500-1600nm region by shifting the zero dispersion region within this area (refer to Figure 8). This kind of fibre is suitable for single-channel transmission systems, since with the introduction of WDM, channels allocated near 1550 nm are seriously affected by noise induced as a result of nonlinear effects caused by Four Wave Mixing (FWM) [3].

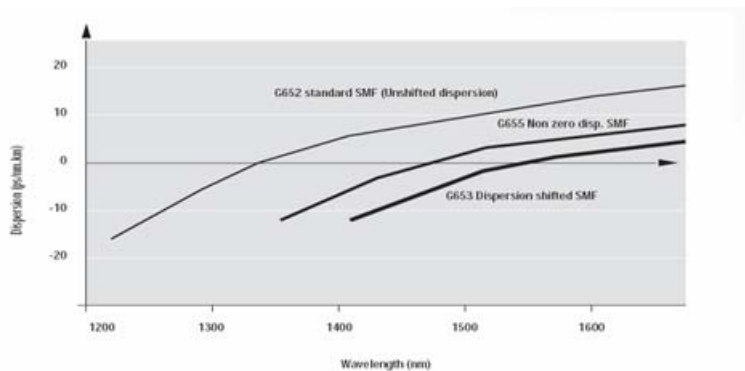


Figure 8: CD comparison for available fibre standards

### 3.3.4. G.655 – Non-Zero Dispersion Shifted Fibre

ITU-T G.655 Non-Zero Dispersion Shifted Fibre represents the latest generation of optical fibres designed for long-haul DWDM transmission at the 1500-1600nm region. As shown in Figure 8, the zero dispersion region is shifted outside the 1500-1600nm region and a small amount of dispersion is introduced in the 1500-1600nm region. This small but finite amount of chromatic dispersion results in minimization of non linear effects, such as FWM, which are seen in DWDM systems without the need for costly dispersion compensation.

### 3.3.5. Fibre Standards Comparison

The following table provides a brief comparison between the discussed fibre standards. As it is shown, despite minor differences among manufacturers, all fibre types present the same attenuation behaviour at the 1550nm region. This does not hold for Chromatic Dispersion values where there are important differences among standards.

ITU-T Standard	Typical Attenuation value (1550nm)	Typical CD value (1550nm)	Applicability
G.652	0.25dB/km	17 ps/nm-km	OK for xWDM
G.652c	0.25dB/km	17 ps/nm-km	Good for CWDM
G.653	0.25dB/km	0 ps/nm-km	Bad for xWDM
G.655	0.25dB/km	4.5 ps/nm-km	Good for DWDM

Table 1: Fibre standards comparison

### **3.4. Optical Fibre Advantages**

Optical fibres present a series of advantages compared with copper and cable. The most important of them are the following:

- Optical fibres are a really broadband medium; nowadays there are commercial products which, by deploying DWDM, enable transmission rates of a few Tbit/s from a single fibre cable at great distances.
- Optical fibres are immune to virtually all kinds of interference; they can work error-free closely to high voltage cables, power lines etc.
- Optical-fibre cables are much smaller and lighter in weight than wire or coaxial cables with similar information carrying capacity; in order to have a comparison measure note that it would take 33 tons of copper to transmit the same amount of information carried by 0.1 kg of optical fibre.
- Optical fibres present increased security, since it is very difficult to intercept signals transmitted through fibre.
- Optical fibres have a low production cost (~euro/km) because they are made of glass ( $\text{SiO}_2$ ) and Silicon (Si) is the most abundant ingredient in earth.

## 4. Utilization of Different Wavelengths for Signal Transmission

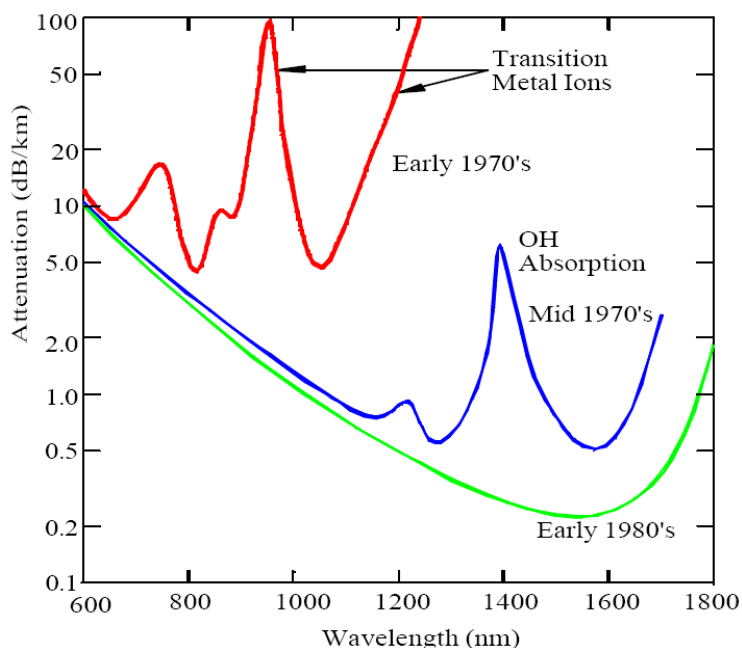
The very first idea of using light as the transmission media for telecommunication applications was published in the beginning of the second half of the 20<sup>th</sup> century. At that time, optical fibres and transmitters were rather immature to be used for even short distance transmission: existing fibres produced nearly 1.000dB/km attenuation; underdeveloped optical transmitter technology used very low output power light sources and dull receiver sensors, all working in the visible wavelength domain, providing very ineffective transmission capabilities.

The very first step forward on the way of creating the fibre optics industry was the development of laser technology. At that time, light-emitting diode (LED) was the only light source small enough to be useful for fibre optics. The idea of using lasers as fibre optic transmitters came in the late 1950s as they were becoming better developed. Lasers went through several generations (helium-neon, ruby, GaAs, etc.) until the realization of the first semiconductor laser diode in the beginning of the 1960s. These laser transmitters are the most widely used in fibre optics technology today together with LEDs. The main advantage of using a laser, compared to a LED is its very narrow bandwidth (between 0.1-5nm in comparison with 25-100nm bandwidth of LEDs), high modulation frequency, higher optical output power and its competence for single-mode (small core sized) fibres. In order to resolve the problem of detector optics, photo-conductive materials and satisfying sensitive photodiodes were being developed jointly with laser technology.

The early receiver and transmitter pairs were extremely slow and ineffective; in addition they worked in a wide wavelength window. As time passed and demand from the telecommunications market grew, more and more accurate transmitters/receivers were introduced. They offered higher transition speed, more appropriate wavelength bands and higher output power.

Fibre optic cables also went through several generations of development before being capable of effective telecommunication transmission. The first fibres had an enormous attenuation – approx. 1000dB/km as detailed above –, which disabled them from providing transmission over a reasonable distance (some km). The high overall attenuation of fibre was caused by metal impurities in the silica-based guide (glass). The very first fibre with a satisfactory attenuation (20dB/km, comparable to coaxial cable attenuation) was constructed in 1970 by Corning Ltd. Shortly after this breakthrough in the mid 1970s, a cleaner silica-based material was realized by eliminating residual metal ions causing attenuation peaks. On Figure 9 the attenuation graph of different fibre generations can be seen.

The earliest fibre optic systems operated at about the 850nm wavelength region (“first window”). This region offers a wavelength window with a reasonable low and homogenous (no peaks) optical attenuation. The 850nm window was very attractive in the beginning as the technology for light emitters and related detectors at this wavelength were mature enough to provide an effective transmission with low-cost equipment. As fibre technology progressed this window became much less attractive due to other possible transmission windows offering lower loss limit in comparison with 3dB/km attenuation of the first window. Figure 9 clearly shows the well-known attenuation peaks of fibre material caused by the so called Rayleigh scattering and hydroxyl ions (OH-) located in the fibre material.



**Figure 9: Optical fibre generations and their attenuation**

As fibre technology developed, other transmission windows were found to be used for more effective optical transmission. The “second window” is located around 1310nm, just beyond an attenuation peak detailed above. This window offers approximately 0.5dB/km attenuation enabling longer distance coverage without any signal amplification or regeneration. In late 1970s, researchers at the Japanese Nippon Telegraph and Telephone (NTT) company started to experiment with a “third window” at around 1550nm. They found that this wavelength range has the lowest possible attenuation of all windows, offering the most effective transmission parameters for long-haul optical communication systems. The theoretical minimum of optical loss is approximately 0.2dB/km in this window.

Modern optical transmission systems are operating in the 850nm, 1310nm and 1550nm wavelength windows, depending on the application they are designed for. All the wavelength ranges have their own advantage. 850nm equipments are designed for multi-mode fibre (MMF) based short-distance transmission (up to 2km usually) with a reasonably low price. The 1310nm systems are used for mid-range transmission (e.g. inside a metro area) using both multi-mode and single-mode fibre (SMF). The third window at 1550nm is the best usable for long-haul multiple wavelengths transmission. These equipments use single-mode fibre and require very precise lasers, filters, detectors and other related components, which always come with a notably higher cost in comparison with 850nm and 1310nm equipment.

## 4.1. Single Wavelength

During the development of the optical communications, three wavelength and surrounding bands (windows) have been used:

- First window with the main wavelength of 850 nm.
- Second window with the main wavelength of 1310 nm.
- Third window with the main wavelength of 1550 nm.

These wavelengths were chosen with different optical parameters (attenuation, dispersion etc) in mind, in order to maximize the effects of digital signal transmission. Defining the windows around the main (centre) wavelengths is necessary because optical transmitters cannot transmit a signal containing only single



wavelength; the signal is dispersed on the surrounding wavelength band (25-100 nm for LED-generated transmission, 0.1-5 nm for Laser Diodes).

The first window is primarily used in local area networks with the multi-mode fibre (MMF) and for relatively short (usually up to 2 km) links. Other two windows are used with the single-mode fibre (SMF), and their main characteristics will be further explained.

As the single-mode fibres and corresponding transmission technologies progressed, new division of wavelength space was defined:

Band	Name	Wavelength Range [nm]
O-band	Original	1260 - 1360
E-band	Extended	1360 - 1460
S-band	Short	1460 - 1530
C-band	Conventional	1530 - 1565
L-band	Long	1565 - 1625
U-band	Ultra-long	1625 - 1675

**Table 2: Single-mode transmission bands**

#### 4.1.1. Wavelength 1310 nm

Wavelength of 1310 nm or second window came into use around mid-1980s. This wavelength has significantly lower attenuation compared with 850 nm, which was predominantly used before. In single-mode applications this wavelength is important because of the zero-dispersion, the result of cancelling chromatic and waveguide dispersions.

Some important characteristics of this wavelength include:

- Suitable for multi-mode and single-mode fibre. Modal bandwidth for multi-mode fibre is around 500 MHz/km with approximately 400 modes.
- 1 nm in 1310 nm band has 177 GHz of bandwidth.
- Attenuation approx. 0.4 dB/km.
- MFD (Mode Field Diameter) ~ 9.3  $\mu\text{m}$ .
- Chromatic dispersion, as defined by the G.652 standard, must be less than 3.5 ps/nm/km.

This wavelength is extensively used in today's network technologies such as Ethernet and SDH/SONET. Although Legacy (10BASE-X) and Fast (100BASE-X) Ethernet standards do not explicitly specify the 1310 nm application, there are products like single-mode fibre media converters which utilize this wavelength. In Gigabit Ethernet 802.3z standard there is a physical specification, 1000BASE-LX, which defines 1310 nm-applications allowing for 550 m MMF and up to 5 km SMF links (all vendors, however, specify 10 km). In the newest 10G Ethernet, there are two Physical Medium Dependent (PMD) sub-layers for 1310 nm window: 10GBASE-L for SMF with links up to 10 km, and 10GBASE-LX4 for MMF and SMF utilizing four nearby wavelengths (1275.7 nm, 1300.2 nm, 1324.7 nm, 1349.2 nm) allowing for 300 m MMF and 10 km SMF links. In SDH/SONET, this wavelength can be used for OC-3/OC-12/OC-48 in Short-, Intermediate- and Long-Reach SMF link applications, allowing for 2, 15 and 40 km links.

#### 4.1.2. Wavelength 1550 nm

The wavelength of 1550 nm or third window is particularly interesting because it has the lowest attenuation of all – as low as 0.13 dB/km. Due to Rayleigh scattering, which is responsible for the most of fibre attenuation

and inversely proportional to the fourth power of the wavelength, and the fact that on 1700 nm and further attenuation significantly grows because of the infrared absorption, the 1550 nm band has emerged as the wavelength of choice for long-haul transmission. However chromatic dispersion has stronger effect on 1550 nm, but its effect could be minimized or even cancelled with the special fibre construction (described in chapter 3.3).

Some important characteristics of this wavelength include:

- Suitable for single-mode fibre only.
- 1 nm in 1550 nm band has 133 GHz of bandwidth.
- Attenuation approx. 0.2 dB/km.
- MFD (Mode Field Diameter) ~ 10.5-11  $\mu\text{m}$ .
- Chromatic dispersion, as defined by the G.652 standard, must be less than 20 ps/nm/km.

This bandwidth is predominantly used on long-haul links. In the Ethernet range, this wavelength is used in the Gigabit Ethernet (via 1000BASE-ZX) and in the 10G Ethernet (via 10GBASE-E) for links up to 100 and 40 km respectively. In SDH/SONET, OC-3/OC-12/OC-48 bandwidths are supported with links up to 80 km.

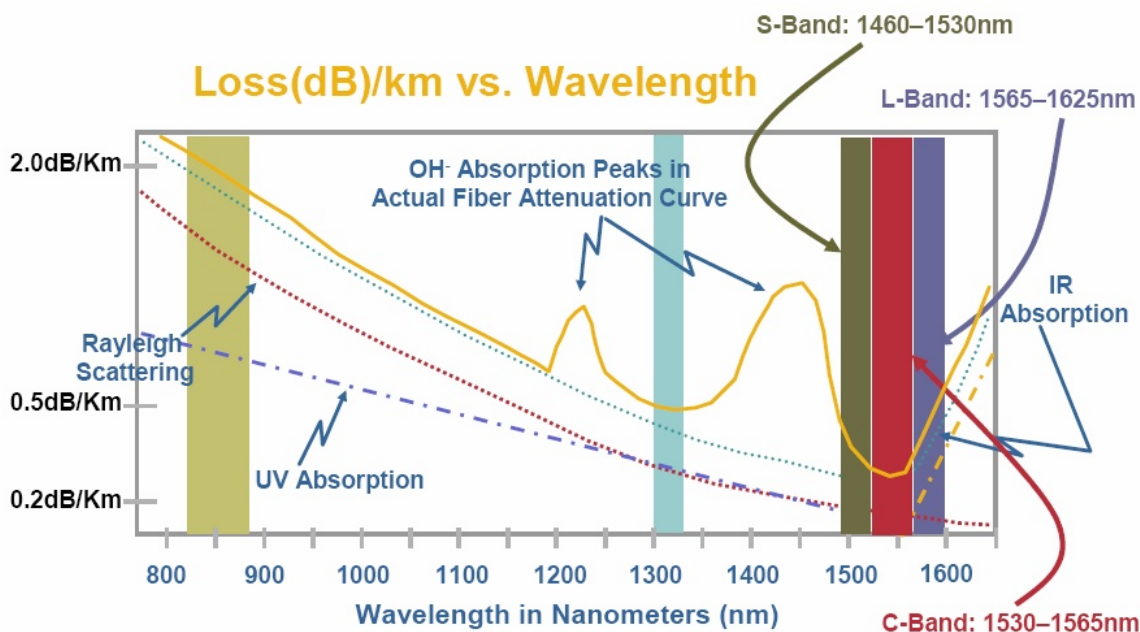
## **4.2. Multi Wavelength**

### **4.2.1. Wavelength Division Multiplexing (WDM)**

Wavelength Division Multiplexing (WDM) technology revolutionized optical data transmission by radically increasing data transmission capacity on a single fibre. WDM technology is able to multiplex several different wavelengths carrying independent data streams into a single optical fibre. The technique is very similar to Frequency Division Multiplexing (FDM) technology: two or more signals using a limited frequency bandwidth are transmitted simultaneously through the medium by assigning a separate part of the available frequency range spectrum to each of the individual channels. This is exactly the same with the WDM technology except that “wavelength” and “light-path” terminology is used instead of frequency channels.

The driving force for using multi channel optical systems for telecommunication applications is the enormously wide frequency bandwidth available in a single optical fibre. Theoretically, more than 20,000Gbit/s data rate can be achieved by base band optical modulation offering an unimaginable high transmission speed for today’s systems.

However, a very small portion of this bandwidth can be used for optical transmission due to several physical phenomena (e.g. OH absorption, Rayleigh scattering, UV and IR absorption, etc.). On the graph below (Figure 10) the attenuation characteristics of an optical fibre can be seen as a function of wavelength in nanometres. The graph shows all the wavelength ranges that could be used for optical transmission as it was detailed in section 4.1.



**Figure 10: Attenuation of an optical fibre and remarkable transmission bands [source: Cisco Systems]**

In order to offer interoperability between different vendors' multi-channel optical networking equipments WDM channel allocation schemes were introduced by ITU-T. These so called channel grid standards cover channel centre frequencies and channel width and other important optical transmission parameters to be followed by manufacturers. For more details on standards, see section 4.2.2 and 4.2.3.

There are several different types of WDM technology, each designed for specific applications:

- CWDM: Coarse Wavelength Division Multiplexing is a moderated WDM technology with less usable wavelength channels specified with a wider channel spacing. The term “coarse” is referring to these simplifications made to system requirements in comparison with DWDM equipments (see below). Wider channel spacing makes the production of CWDM equipment cheaper than DWDM equipment, enabling cost effective deployment of WDM technology in metro or other short-range applications. In order to bring different vendors' products to common platform, a CWDM channel specification was created by the ITU-T. See technical details in section 4.2.3.
- DWDM: Dense Wavelength Division Multiplexing technology was designed to support long-haul (even several thousands of kilometres) optical transmission applications. DWDM systems only operate in the third (in C and L bands) wavelength window obtaining the lowest possible optical attenuation. The word “dense” is referring to the high number of narrow banded transmission channels made available in this window. DWDM equipments are significantly more expensive than CWDM systems, as lasers, filters and other related components need to be significantly more stable and precise. The principles of DWDM channel spacing, width and central wavelengths of each channel were also standardized by the ITU-T. A detailed description of DWDM technology can be read in section 4.2.2.
- FWDM: Filter Wavelength Division Multiplexing is the simplest WDM technology, divides the transmission band into two sub-bands only. FWDM is typically used for single fibre bidirectional transmission; however it is possible to use FWDM to double transmission capacity. This technology has no special demand to transmitter stability (comparing to CWDM and especially DWDM) although filters must be broad enough. FWDM is usable both for MMF (850/1310 nm) and for SMF with a lot of combinations, e.g. 1310/1550 nm, 1550/1625 nm, S/L bands, C/L bands etc.

### 4.2.2. Dense Wavelength Division Multiplexing (DWDM) in C band

Dense Wavelength Division Multiplexing (DWDM) with its wide applicability, high capacity and flexibility is the most advanced WDM technology of all existing multi channel optical transmission technologies.

Key features and benefits of DWDM technology are the following:

- ITU-T standards based technology for the maximum interoperability between different manufacturers' equipments.
- High capacity: large number of optical channels available providing large transmission capacities. Narrow frequency bandwidth channel spacing (200GHz, 100GHz or 50GHz spacing) provides a satisfying channel density for demanding applications.
- Long-haul (up to several thousands of kilometres) transmission capabilities supported by DWDM building blocks (e.g. regenerators, amplifiers, etc. See next sections.).
- Operates in the third window at 1550nm (C and L band) offering the lowest possible attenuation for long-haul applications. Economical implementations of optical amplifiers also perform in this transmission window.
- Scalability: purchase equipment when an additional wavelength (often referred as lambda) needed.
- Wide range of building blocks for providing network flexibility, stability and protection.

In the following section 4.3, dealing with CWDM technology, a short comparison of CWDM and DWDM systems can be found (Table 3), closely based on technical parameters of each transmission technology. The table clearly shows that DWDM requires much more precise lasers, filters and other related basic components, allowing the usage of a high number of narrow-band optical channels in contrast with CWDM technology, where only a low number of channels with a reasonable wide wavelength width are specified.

#### 4.2.2.1 Standards

Different layers of optical networks are covered by several ITU-T recommendations. ITU-T has been standardizing optical network technologies under the name Optical Transport Networks (OTNs). In this section OTN physical layer related ITU recommendations will be introduced.

Concerning DWDM transmission systems' interoperability issues, two different areas of basic interoperability should be identified [1]:

- Transverse compatibility: multi-vendor interoperability along the optical fibre. For such interoperability a full set of optical parameters should be recommended for manufacturers: output power, channel central frequency, maximum variance from channel central frequency, channel encoding, maximum fibre attenuation, chromatic dispersion, maximum bit error ratio, etc.
- Longitudinal compatibility: this type of compatibility needs minimal requirements specification for receivers and transmitters in order to provide identical transmission distances regardless of the receiver/transmitter belonging to each manufacturer. Without longitudinal compatibility, it would be impossible to apply general design guidelines without being glued to a specific manufacturer. This type of interoperability needs specification of e.g. maximal attenuation, chromatic dispersion, lengths of spans to be targeted with/without amplification and regeneration.

ITU-T recommendations dealing with the above interoperability issues:

ITU-T G.692 "Optical interfaces for multi-channel systems with optical amplifiers" (1998). This recommendation specifies multi-channel (4, 8 or 16 channels) unidirectional and bi-directional SDH optical transmission system interfaces in order to provide *transverse* compatibility among different SDH optical systems operating on G.652, G.653 and G.655 optical fibres. This document also specifies nominal span lengths (80km, 120km and 160km) with and without inline optical amplifiers and regenerators to be targeted by manufacturers. Furthermore, it also defines a basic frequency grid anchored at the central frequency 193.1THz (1553.52nm, middle of EDFAs' amplification range) with a channel spacing of 100GHz with no defined lower or upper bound. The reason behind choosing 100GHz was its suitability for the applications defined in G.692 [2].

G.692 was the very first ITU-T recommendation dealing with multi-channel optical transmission systems. At that time only SDH and SONET systems were targeted to be transmitted using DWDM technology. A more extensive definition of DWDM channel structure is published in ITU-T G.694.1 “Spectral Grid for WDM Applications – DWDM Frequency Grid” (2002) offering a *longitudinal* equipment compatibility. G.694.1 recommendation supports the following channel spacing: 12.5GHz, 25GHz, 50GHz, 100GHz and 200GHz. Please note that the original central frequency specified in G.692 was not modified by this document, it was only extended in order to serve advanced networking applications by providing a higher density of optical channels independently from the framing used for transmission [1].

Considering e.g. 100GHz channel spacing, G.694.1 defines approximately 150 different 100GHz channels in DWDM transmission bands S, C and L. Lowering channel separation towards 50GHz or even narrower gives an enormous number of DWDM channels to be used. As state of the art equipments mainly operate in C band, they are limited by not utilizing S and L bands, however with a 25GHz channel spacing it would be possible to handle more than 150 channels in C band only.

Most common equipment currently available on the market supports either 4, 8 or 16 wavelength channels with 200GHz or 100GHz spacing. More advanced – and thus more expensive – DWDM systems can scale up to 80 channels with 50GHz and up to 160 channels with 25GHz channel spacing. However, for 10Gbit/s transmission 50GHz channel bandwidth is needed as a minimum to fit the spectrum of such a high-speed signal into an optical channel.

Despite the frequency grid specified by ITU-T recommendations, manufacturers and users are free to use any wavelengths from any part of the fibre spectrum. It is usual that a manufacturer use slightly different channel layout by extending the lower and upper boundaries of the spectrum covered by ITU-T specifications.

#### **4.2.2.2 Applications**

As detailed above, DWDM technology was designed to serve capacity-demanding global telecommunication applications. The third optical transmission window at 1550nm enables a gradual deployment of short-, middle- and long-haul applications by offering the lowest possible optical attenuation and the widest range of building blocks available for DWDM network construction. Today’s driving applications of DWDM transmission systems are the followings:

- Long-haul and ultra long-haul submarine and terrestrial applications: connecting MAN networks (cities), countries and continents, etc. DWDM technology allows economic usage of expensive international fibres deployed between continents and countries.
- Metro Area Networks: DWDM is emerging in this field driven by huge capacity demands present in metropolitan areas thank to exponential growth of Internet penetration. Broadband access technologies obviously require a high capacity and gradually scalable aggregation network.
- DWDM technology in general provides economic facilities to operate different overlay networks side by side without affecting each other (e.g. SDH/SONET and IP network).
- Passive Optical Networks (PON): DWDM plays an important role in implementing FTTx (Fibre To The Home/Curb/Building/...) access technologies by enabling the economic use of aggregation fibres.

#### **4.2.2.3 General Introduction of DWDM Building Blocks**

In this section, all the important DWDM building blocks will be covered in order to give an overview of the basic DWDM network elements. In further sections of this document a more detailed description can be found regarding some of these building blocks, please see references in the text below.

##### **4.2.2.3.1 Amplifiers**

To reach a certain span with a DWDM system it is essential to amplify somehow the optical signal after long travel and attenuation in the optical fibre. The amplification systems can be classified according to the regeneration capabilities: 1R, 2R, or 3R. These abbreviations cover the following:

- 1R - reamplification only: amplify amplitude of light impulses.

- 2R - reamplification and reshaping: amplification and resetting impulse shape damaged by dispersion and PMD (see section 9.2). This method provides some form of data recovery.
- 3R - reamplification, reshaping and retiming: 2R + retiming of impulses. This technique usually requires very accurate time sources for retiming and today it can not be done without optical-electronic-optical (OEO) conversion.

The optical amplifiers are responsible to amplify the wavelength multiplexed signals to certain levels. One classifies the amplifiers according to location in DWDM system:

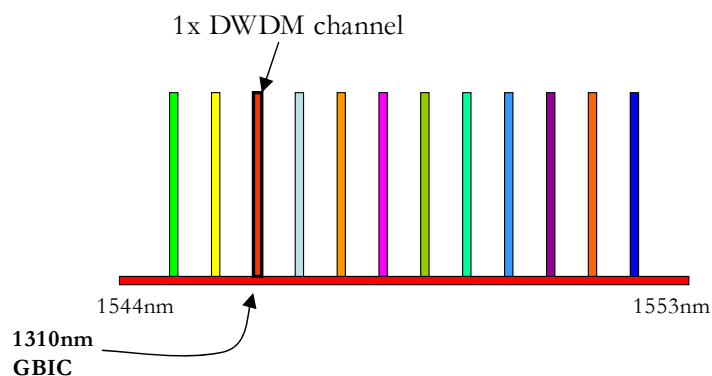
- Pre-amplifiers: boost the signal pulses at the receiver side.
- Post-amplifiers: boost the signal pulses at the transmitter side.
- In-line amplifiers: placed a certain distance from the source to provide recovery for the signal before it is degraded from loss.

Optical signals cannot be amplified arbitrarily without 2R/3R regeneration because of the noise intensified by the amplifiers (OSNR drops), dispersion and some special non linear effects like self/cross-phase modulation (SPM/XPM) and simply because of overheating of the fibre.

The technical properties of optical amplifiers strongly affect the transmission bands used by DWDM equipment. The most effective and cheap amplifiers perform in transmission band C, this lead nearly all commercially available optical systems to work in band C. In general, there are several different types of optical amplifiers available on the market; the most widely deployed amplifiers will be covered in section 6.1.

#### 4.2.2.3.2 Transponders

Transponders convert a baseband optical signal used by conventional optical systems (850nm, 1310nm or even 1550nm baseband transmitted signals) to a specific wavelength (to S, C and L bands) usually via OEO conversion. In practice, this operation needs wavelength conversion and signal adaptation, as well as 2R or 3R regeneration functions.



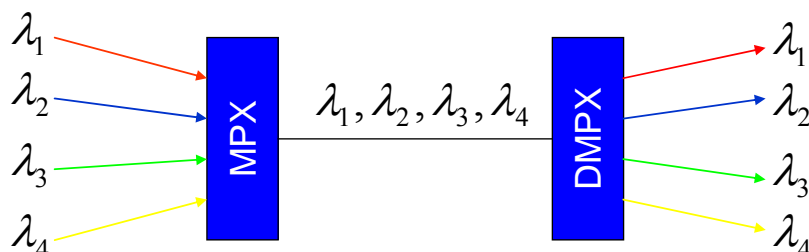
**Figure 11: Converting a baseband optical signal to fit into a grid of DWDM channels**

On Figure 11 a basic transponder operation is shown. A 1310nm baseband Gigabit Ethernet signal originated by a conventional optical transmission system (e.g. router, switch, etc.) is shifted to a specific frequency in order to fit into the DWDM grid currently allocated on the fibre. A DWDM transponder uses a narrowband laser or even wavelength filtering to accurately match into the channel grid without any interference with other signals already multiplexed into the optical fibre.

On the receiver side, it is also the task of the transponder unit to receive the optical DWDM signal from the demultiplexer device and to convert its input into a signal that is ready for baseband transmission towards a convention optical device.

### 4.2.2.3.3 Multiplexer/demultiplexer

A DWDM multiplexer is responsible for combining different ITU-T defined discrete wavelengths into a single multiplexed signal that can be transferred using an optical fibre. On the left hand part of Figure 12 a WDM multiplexer can be seen with four different client signals on its input. A client signal is originated by a conventional switch or router using baseband transmission. It is the task of a transponder to receive a client signal (see above) and convert it to the appropriate wavelength channel according to the frequency grid. A properly prepared output signal of a transponder is ready to be multiplexed by the multiplexer device as shown below.



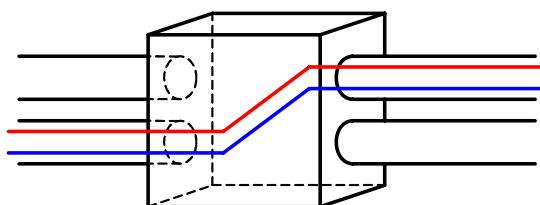
**Figure 12: WDM multiplexer and demultiplexer**

A demultiplexer device exactly does the reverse operation of what a multiplexer does. A DWDM demultiplexer is used for separating (demultiplexing) different wavelength channels from the multiplexed beam into several ITU-T compliant single wavelengths (Figure 12). As conventional optical systems are usually not able to receive a direct DWDM compatible signal, a transponder is needed to turn a specific DWDM channel into a conventional baseband signal. However, there are so called "colored" optical router/switch interfaces on the market, using a specific predefined wavelength to transmit/receive. In this case, no transponders are needed between the multiplexer/demultiplexer and the router/switch, as the signals are suitable to connect directly to the multiplexer/demultiplexer.

### 4.2.2.3.4 Optical Cross Connect (OXC)

In today's optical networking a fibre carrying 40 different wavelengths can be usual. In such an environment it is highly desirable to physically connect a plenty of fibres in a flexible, reconfigurable manner or switch wavelengths from each fibre to the other, etc. Glued to ordinary PSTN terminology, an Optical Cross Connect device can do the job. An OXC with full functionality should cover the following three major areas:

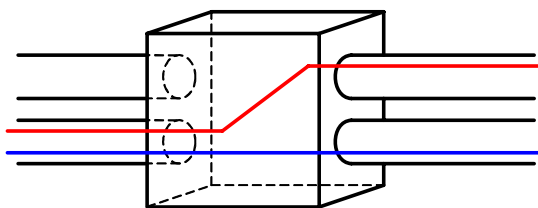
- Fibre switching: the cross connect physically links fibres as it is desired by the network operator. The type of switching could be manual or remotely controlled (depending on the switch). The internal design of such a switch contains a so called optical space switch that is capable of interconnecting different fibre pairs (Figure 13).



**Figure 13: Fibre switching**

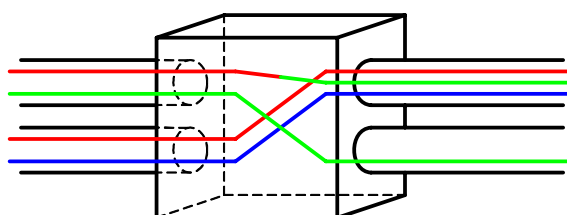
- Wavelength switching: a more advanced functionality of a cross connect. This technique allows switching of different wavelengths from each fibre to the other one. Apart from fibre switching this

operation requires a rather complicated internal OXC build-up using tunable/selectable filters and advanced optical space switching mechanisms (Figure 14).



**Figure 14: Wavelength switching**

- Wavelength conversion: when a plenty of different wavelengths are switched between fibres, there could be a need for converting some of these wavelengths to a different one, in order to accommodate this wavelength to the location of another channel to avoid blocking the designated way of the specific light path (Figure 15).



**Figure 15: Wavelength conversion**

OXC devices currently available on the market usually implement a subset of this functionality. There are rather simple physical OXCs implementing a fibre switching facility, even remotely controlled, to ease the task of reorganizing (i.e. cabling) the network. Other, more sophisticated OXC designs also realize wavelength switching and conversion allowing the network operator to handle and reconfigure its network in the most effective way.

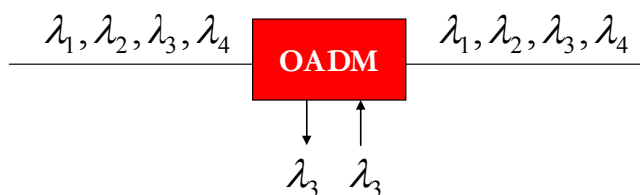
On the diagrams above, only a very small capacity 2x2 OXC is shown, that is able to work with two input and two output fibres. However, much larger (e.g. 32x32) OXCs are available on the market. The key component of such an OXC is the way the switch fabric is implemented. There are plenty of working solutions used in today's equipments, but the most promising of them is the so called MEMS (Micro Electro-Mechanical Systems) technology. MEMS is using electronically controlled microscopic mirrors to link each input to a designated output.

#### **4.2.2.3.5 Optical Add Drop Multiplexer (OADM)**

Between a multiplexer and a demultiplexer device there are plenty of wavelength channels travelling along the fibre. It could be desirable to detach some of these channels at an intermediate point on a transmission line from the whole multiplexed signal and to add new signals to the locations disengaged. An Optical Add Drop Multiplexer device installed at such a point allows adding new signals and decoupling the existing ones to/from the multiplexed beam being transmitted on the fibre.

In a typical usage scenario, most signals pass through the device unchanged, but some of them are dropped from the multiplexed signal by splitting them from the beam. As some of the channels were dropped, new ones could be added at the same OADM device originated by some transmission device (router/switch) located behind the OADM. In Figure 16 an OADM can be seen with one signal detached from the multiplexed beam ( $\lambda_3$ ) and a new wavelength channel is added to the fibre.





**Figure 16: Optical Add Drop Multiplexer layout**

A more advanced version of OADMs is the so called Reconfigurable OADM (ROADM). This type of devices enable the network operator to reconfigure its OADMs remotely as actual capacity needs require, thus increasing network flexibility and efficiency. See section 8.1 for more detailed description of OADM and section 8.2 for ROADM devices.

#### 4.2.2.4 Important parameters of DWDM Systems

When procuring a DWDM network component there are plenty of technical parameters that should be considered before purchasing the chosen device. Some – not all – of the most important parameters are:

- Whole system:
  - Connector type - usually SC or LC.
  - Channel spacing used and capacity (number of channels handled).
  - Scalability, modularity: wavelength granularity, expenses of establishing an additional wavelength.
  - Protocol awareness (e.g. SDH/SONET, Gigabit Ethernet, etc.).
  - Network protection, failover capabilities.
  - Management: a device can be passive or active. Active devices need remote management.
- Transmitters/receivers:
  - Output power
  - Input sensitivity (dB)
  - Dispersion tolerance (ps/nm).
- Amplifiers:
  - Amplification bandwidth
  - Gain (dB): output power/input power.
  - Noise figure, OSNR (dB)
- OADM/ROADM:
  - Insertion and return loss (dB).
  - Number of wavelengths handled (added/dropped).
  - Channel isolation (dB).
- Multiplexer/demultiplexer:
  - Insertion and return loss (dB).
  - Channel isolation (dB).
  - Crosstalk suppression (demultiplexing).

A short listing of the most important DWDM equipment manufacturers and their relevant platforms can be found at: <http://www.seefire.org/publications.php?language=en>

### 4.2.3. Coarse Wavelength Division Multiplexing (CWDM)

#### 4.2.3.1 Overview

Coarse Wavelength Division Multiplexing (CWDM) is a form of WDM with fewer wavelengths, and with wider spacing between the wavelengths (compared to DWDM). The cost of CWDM equipment can be significantly lower than DWDM due to the following factors:

- Transmitting lasers can have greater spectral width and thermal drift, because neighbouring wavelengths are not as close as in DWDM.
- Uncooled laser technology requires less power, and, therefore, easier packaging
- Fewer films are needed for multiplexer/demultiplexer.

A brief comparison of CWDM and DWDM is given in the following table.

Parameter	CWDM	DWDM
<b>Wavelength spacing</b>	20 nm	1.6 nm (200 GHz) 0.8 nm (100 GHz) 0.4 nm (50 GHz)
<b>The number of wavelengths</b>	18 (G.694.2)	16-32 (metro) 40-80 (long distance)
<b>Laser technology</b>	Uncooled DFB	Cooled DFB
<b>Bands</b>	O+E+S+C+L	C+L
<b>Filter technology</b>	Thin film	Thin film, Grating, AWG

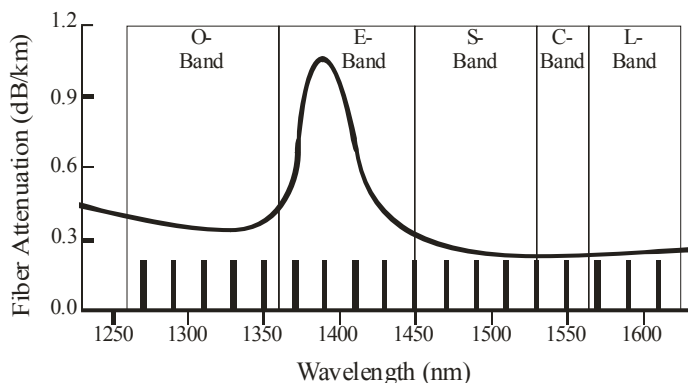
**Table 3: CWDM & DWDM technologies comparison**

In the following chapters we will describe CWDM standards and types of the CWDM devices with examples of product range for important vendors like Cisco and Finisar.

#### 4.2.3.2 Standards

There are two ITU-T standard regarding CWDM:

1. ITU-T G.694.2 “Spectral grids for WDM applications: CWDM wavelength grid”. This standard defines 18 centre wavelengths (from 1271 nm to 1611 nm) with 20 nm wavelength spacing (Figure 17).



**Figure 17: G.694.2 wavelength grid**

2. ITU-T G.695 “Optical interfaces for coarse wavelength division multiplexing applications”. This standard defines physical parameters for 4-channel, 8-channel and 16-channel operation like Aggregate Output, Optical Path, Aggregate Input etc. Also, it defines new nomenclature of the CWDM systems in the forms of CnW<sub>x</sub>-yztz (unidirectional) and B-CnW<sub>x</sub>-yztz (bidirectional), where:
  - n is the maximum number of channel supported;
  - w indicates span distance (‘S’ for short-haul, ‘L’ for long-haul);
  - x is the maximum number of spans;
  - y indicates highest class of optical tributary signal supported (‘0’ for NRZ 1.25G, ‘1’ for NRZ 2.5G);
  - t indicates supported configuration (‘D’ for configuration with no optical amplifiers);
  - z indicates fibre type (‘2’ for G.652, ‘3’ for G.653, ‘5’ for G.652);

Using this nomenclature, application code for the 4-channel long-haul G.655 multiplexer would be C4L1-1D5.

It is interesting to note that G.695 standard meetings attracted more participants than any other meetings of ITU-T bodies in that last three years, showing incredible industry interest for CWDM and its standardization.

#### **4.2.3.3 Application**

CWDM technology’s main targets are Metropolitan Area Networks. However, since present 1Gbit/s CWDM interfaces have typically 30dB optical budget and with typical attenuation, over G.652 fibre, around 0.25dB/km at 1550nm (and a little bit higher at the ends of S and L bands), CWDM can be a good solution for WANs and the interconnection over dark fibre at distances up to 100km. This solution is used in several European NRENs (SANET, ARNES, AMREJ)

If more then 100km reach is required, some sort of signal amplification or regeneration is needed. Amplification of more then two to three CWDM wavelengths with one single amplifier is difficult because of relatively narrow gain bandwidth of amplifiers which can be found on the market at the moment.

#### **4.2.3.4 Devices**

Devices for CWDM applications are:

- Optical Multiplexer/Demultiplexer. This device multiplexes a number of wavelengths from different user ports to the aggregate signal on the network port.
- Optical Add-Drop Multiplexer (OADM) – described in chapter 8.1.

- CWDM Transceivers (GBIC, SFP) – described in chapters 10.1.1 and 10.1.2.

It should be noted that CWDM multiplexers/demultiplexers and OADMs are completely passive devices and require no electrical power.

There are two basic types of CWDM systems: GBIC-based and transponder based. In GBIC-based systems, the end-devices (like switches and routers) generate signals via defined wavelength using appropriate CWDM GBIC or SFP. In that case, the devices can be connected directly to a Mux/Demux/OADM, but they have to be GBIC- or SFP-enabled, and each end-device must have its own wavelength assigned. In transponder-based systems, the end-devices transmit via usual wavelengths (such as 1310 nm or 1550 nm) and their signals enter the transponder. The transponder regenerates those signals using different wavelengths, and creates aggregate signal on the network side. An example of transponder-based system is Transmode's TM series, an example of GBIC-based system, which we will concentrate on, is part of the Cisco CWDM product range.

Although the 694.2 standard specifies 18 CWDM wavelengths, the first and the last wavelength are considered to be unusable because of the high attenuation, resulting in maximum 16-channel application in practice. Furthermore, due to large installation of water-peak cables, the majority of products are offering 4- and 8-channel applications, in the range of 1470 to 1610 nm.

Most products for GBIC-based CWDM systems, although coming from different vendors, are actually very similar. Some additional features or specific parameter values to look at are:

- Insertion loss for the Mux/Demux/OADM. Typically one can expect maximum insertion loss at 2 dB.
- Type of connectors (SC, LC).
- Existence of the monitor port. The monitor port matches the "Network" or the "Pass" port of Mux/Demux/OADM and can be used for an optical power meter or a network analyzer.

The Cisco CWDM product range comprises of the two-module chassis (P/N CWDM-CHASSIS-2) and different modules. There are two different ranges of modules. The old one is on EOS (End-of-sale) from March 27 2005 and contains the following modules:

- 4-Channel Multiplexer/Demultiplexer Module (CWDM-MUX-4=)
- 8-Channel Multiplexer/Demultiplexer Module (CWDM-MUX-8=)
- Add-Drop Module (CWDM-MUX-AD-{1470,1490,1510,1530,1550,1570,1590,1610}=)

A new range contains the following modules:

- 8-Channel Multiplexer/Demultiplexer Module (CWDM-MUX-8A=)
- 4-Channel Single Fibre Multiplexer/Demultiplexer Module (CWDM-MUX-4-SF{1,2}=)
- 4-Channel Add-Drop Module (CWDM-OADM4-{1,2}=)
- Single Wavelength Dual Channel Add-Drop Module (CWDM-OADM1-{1470,1490,1510,1530,1550,1570,1590,1610}=)

Some notable differences between the old and new Cisco CWDM product ranges are 20-50% reduced insertion loss, monitor port, LC instead of SC connectors and transparency for the 1310 nm wavelength.

The Finisar CWDM product range is quite similar, and contains the standalone ("Optibox") or rack-mountable ("Plugin") chassis with the following modules:

- 4-Channel Multiplexer/Demultiplexer (MUX-DEMUX-4-P-{SC,LC})
- 8-Channel Multiplexer/Demultiplexer (MUX-DEMUX-8-P-{SC,LC})
- Single Wavelength Dual Channel Add-Drop Module (FSW-OADM1-{47,49,51,53,55,57,59,61})
- 4-Channel Add-Drop Module (FWS-OADM-4-{1,2}=)

## 5. Optical Signal Modulations

The basic question for an optical communication system is: how to convert an electrical signal into an optical stream? It means that light from the optical source must be modulated and this modulation can be either direct or indirect. For direct modulation, the optical source (laser or LED) is directly modulated by the applied electrical signal. For indirect, external, modulation, the optical source is a continuous wave laser and the electric signal is applied to an external modulator. Direct modulation is more suitable to lower bit rates (up to 2.5 Gbit/s) and shorter distances for Metropolitan Area Network (MAN) and external modulation to higher bit rates (10 Gbit/s and higher) and long distances (the reason is that the modulating electric signal is applied directly to a laser and optical properties of a laser temporarily vary – this is known as the chirping effect). [9], [10], [11]

### 5.1. Modulation Formats

The simplest modulation technique is to change the signal power between two levels (logical ones and zeros) and this technique is called the On-Off Keying (OOK). It is a very simple modulation scheme and is referred to as intensity modulation with direct detection (IM/DD). There is no phase coherence between transmitter and receiver and the optical signal is modulated in the intensity (amplitude) only. Such a scheme is easy to implement and is cost-effective.

But alternative modulation formats, well known from radio and microwave systems literature, utilize the frequency or the phase modulation of the optical signal and use coherent detection techniques, in which the optical signal at the receiver is combined coherently with a Continuous Wave (CW) from an optical source before it is detected (both the amplitude and the phase is detected). A CW signal is generated locally and the CW source is called a Local Oscillator (LO). The reasons for implementing the coherent schemes are the improvement of the receiver sensitivity up to 20 dB when compared to IM/DD schemes [9] and more efficient use of bandwidth by increasing the spectral efficiency. Some coherent schemes have better tolerance to nonlinear effects and dispersions (be it chromatic or polarization mode dispersions) and exhibit better performance. Unfortunately, these nice features come at a price – coherent communications systems are more complicated and more expensive.

Different modulation formats are used for optical coherent communication systems: amplitude shift keying (ASK), phase shift keying (PSK) and frequency shift keying (FSK) are the basic ones. A variant of PSK called differential PSK (DPSK) seems to be very promising for better tolerance to optical impairments and very good performance when compared to other modulation formats. More advanced modulations like differential quadrature phase-shift keying (DQPSK), used for Wi-Fi today, and Optical Duo Binary ODB (also known as phase shaped binary modulation) are multilevel modulations to achieve even higher spectral efficiency. For DQPSK, information is encoded in the 4 differential optical phases between successive bits, for ODB in its simplest scheme, two consecutive bits are summed and a three-level code is created (it is a superposition of amplitude modulation AM and PSK).

### 5.2. Signal Formats

There are two basic signal formats used in optical communication systems: nonreturn to zero (NRZ) and return to zero (RZ). In the NRZ format, the logic one is lighted for the full bit slot, whereas in the RZ format the one is just a fraction of the bit slot (typically 1/3 or 1/2). NRZ is the most widespread and cost-effective technology (together with OOK modulation format) but RZ is a promising technology at higher bit rates (10 Gbit/s) because it can take advantage of so-called dispersion managed soliton transmissions to avoid signal degradation, as it compensates the effects of chromatic dispersion. But an advantage of the NRZ signal format is the smaller signal bandwidth than that of the RZ format (approx. by about a factor of two).

Other signal formats like Carrier Suppressed (CS), Single Side Band (SSB), Vestigial Sideband (VSB), Chirped (C) do exist and are applicable both for RZ and NRZ (CS-RZ, C-RZ,...) signal formats, but they are not so widespread as NRZ or RZ because of complexity (and therefore higher prices) of transmitters and receivers. But these new signal formats have been studied extensively because they are more robust to

perturbations in the optical fibres, as well as in relation to the aforementioned advanced coherent modulation formats.

Above all, RZ-DPSK, NRZ-DPSK, CS-RZ OOK and RZ-ODB have been studied extensively (better tolerance to different optical impairments). [13], [14].

## 6. Fibre Lighting

A number of different phenomena limit the fibre length between transmitter and receiver. Among the most important we can find attenuation and chromatic dispersion. Their common characterization is that they can be “compensated” in a relatively easy way. By **attenuation** suffers any optical signal propagating in any transmission medium (with the exception of void space) and this must be compensated by amplifying the signal. Chapter 6.1 deals with optical amplifiers suitable for fibre transmission systems. Any transmission medium (with the exception of void space) exhibit also **chromatic dispersion** (CD) because the refractive index (RI) (i.e. light speed) varies with signal wavelength. Unfortunately, a non laser source generates just one wavelength (typical spectral line-width is about 0.2 to 5 nm). The travel time of each wavelength through a fibre is different and as a result an initially narrow pulse is widened. This is called **material dispersion**. **Waveguide dispersion**, occurs when the light in the SMF travels also in the cladding, which has a different RI (i.e. different speed) from the core material. Chapter 6.2 deals with CD and its compensation.

### 6.1. Amplification

As mentioned above, one of the most important fibre span-length limiting factor is attenuation, not only fibre attenuation but also attenuation of passive components (MUX, DEMUX, isolators, ..), connectors and so on. For very long fibre spans, the optical signal may be so attenuated that it becomes too weak to be detected properly. To reach destinations that are hundreds of kilometres away, the optical power level of the signal must be periodically conditioned.

The original approach was to regenerate the optical signal (the optical signal is converted to an electronic signal): in this process the electronic signal is retimed, reshaped and re-amplified (also known as 3R) and then is converted back to an optical signal. The regenerator must perform this 3R on a per-wavelength basis. Consequently in DWDM systems a great number of regenerators would be necessary ( #wavelength x (#spans-1) ) to maintain the signals. The increase in number of regenerators entails high material and maintenance cost with high probability of failure. These drawbacks have been overcome with development and deployment of optical amplifiers (OA).

The basic common characteristics of optical amplifiers are gain, bandwidth, gain saturation, noise, polarization sensitivity and output saturation power. The gain is the ratio of output power to input power in dB. The bandwidth is the wavelength range over which the amplifier is effective. The gain saturation is the maximum output power, which cannot increase even when increasing the input power. The polarization sensitivity is the dependence of gain on the input signal polarization. The output saturation power is the output power for which gain of OA falls by 3 dB. The inherent characteristic of an optical amplifier is a noise, which contaminates the optical signal and decreases the output optical-signal-to-noise-ratio (OSNR). In practice, a widely used parameter is noise figure (NF), which represents the ratio of input OSNR to output OSNR of amplifier.

The ideal OA should provide polarization independent high gain, broad bandwidth with high output power and do not decrease the output OSNR.

We can distinguish three most commonly used OA types:

- Optical fibre amplifiers
- Semiconductor OA (SOA)
- Raman OA

#### 6.1.1. Optical Fibre Amplifiers

An active environment of Optical Fibre Amplifiers is represented by a special fibre doped with one or more rare earth element. In practise such rare elements as Er, Nd, Pr, Tm are used alone or in a combinations such as Er+Yb, Tm+Yb.

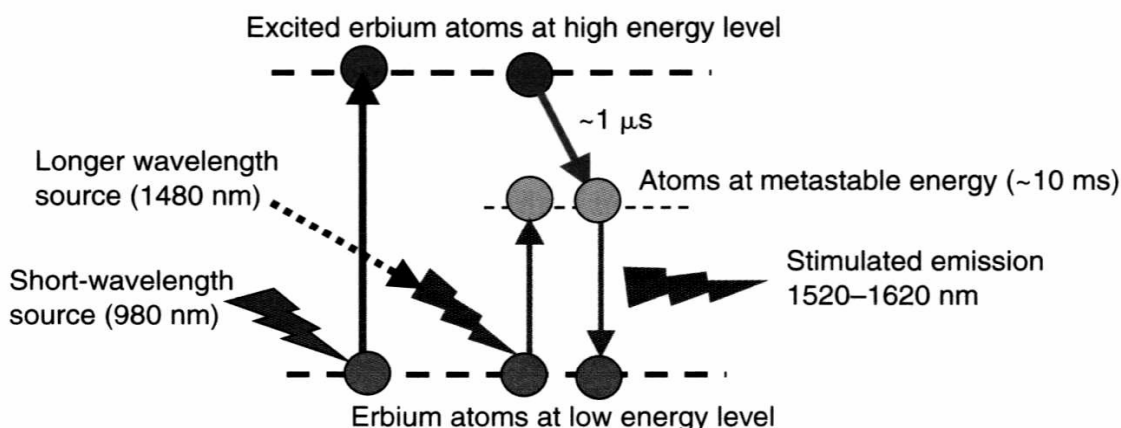
The purpose of rare element ions is to absorb optical pump energy at one spectral range and under input signal stimulation to emit optical energy at another spectral range (especially in a range corresponding to some fibre

transmission band, e.g. O, C, L and so on). Each element has its own absorption-emission characteristic; some elements absorb energy in one single step, others in multiple steps. Similarly, some elements emit light in one or more spectral ranges. Additionally, some elements emit energy out of transmission spectra or the excited atoms do not remain in the excited state long time enough. As the result, there is no single rare element that covers the complete communication transmission spectrum.

There is no doubt that the most widely used Optical Fibre Amplifiers are Erbium doped fibre amplifiers (EDFA); sometimes Praseodymium or Thulium doped fibre amplifiers (PDFA respectively TDFA) are used.

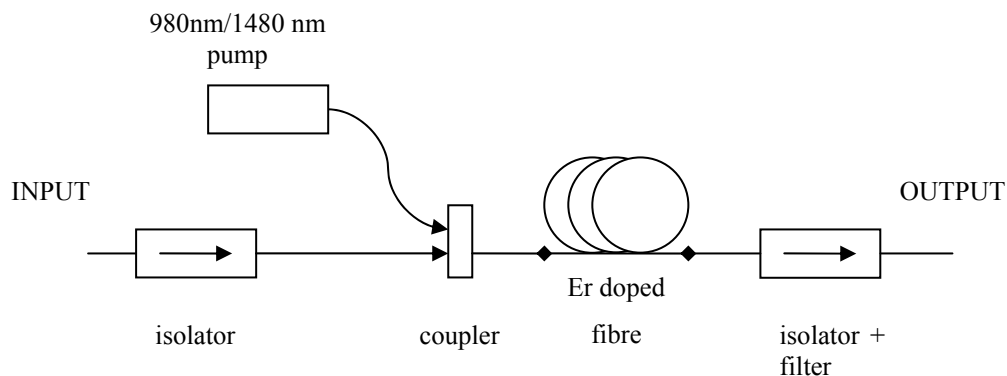
### 6.1.1.1 EDFAs

As mentioned above the EDFAs are the most widespread OA type in communications, because of the two following reasons: a) their spectral emission range corresponds with C-band where G.652 fibre attenuation is the lowest, see Figure 17; b) due to simple fabrication, by erbium is doped common silica fibre. The erbium ions may be excited by a pump to different energy level, from where they may drop one intermediate metastable level at time, until they reach the lowest metastable level. From there it finally drops to the ground level, emitting photons around wavelength 1550 nm. As the pump, the 980 nm and 1480 nm wavelength are typically used. Principle of EDFA operation (excitation followed by stimulated emission) is shown at Figure 18.



**Figure 18: EDFA operation principle [11]**

The simplified EDFA setup is depicted at Figure 19, amplifier consists of a coupling device, pump laser(s), an erbium-doped fibre (can be co-pumped, counter pumped or pumped in both directions), and two isolators located in both ends of EDFA.



**Figure 19: EDFA configuration**



**EDFAs advantages:**

- Wide operating range of 80 nm (typ. 1530-1610nm), thus suitable for C-band and with modification for L-band.
- High gain up to  $G > 45\text{dB}$ .
- High output power up to  $P_{\text{out}} > 37\text{ dBm}$ .
- Relatively low NF in range of  $<3.5, 7>\text{dB}$ .
- Multi-channel crosstalk very low.
- Polarization independent device.

**EDFAs disadvantages:**

- Not a small device (thousand meters of Er doped fibre) and cannot be integrated with other semiconductors.
- Gain spectrum not inherently flat.

**6.1.1.2 PDFAs**

For amplification in original communication band (O-band) praseodymium (Pr) fibre amplifier can be used. Active environment creates Pr doped non-silica (fluoride) fibre pumped typically at 1017 nm. PDFAs cover typically spectral range from 1280 to 1340 nm and offer quite high gain  $G > 30\text{dB}$ , output power  $P_{\text{out}} > 16\text{ dBm}$ , with  $\text{NF} < 7\text{dB}$ . Due to hydroscopic nature and impossibility to splice fluoride fibres PDFAs have not been widely deployed yet.

**6.1.1.3 TDFAs**

As DWDM systems expand the necessity for new transmission bands (extra C and L) is emerging. Such space can be found e.g. in the S band. For amplification the Thulium (Tm) doped fluoride fibre can be used with the pump wavelength 1047 nm and spectral usability range from 1440 to 1520 nm. Gain can be expected  $G > 30\text{dB}$ , with  $P_{\text{out}} > 20\text{ dBm}$  and  $\text{NF} < 7\text{dB}$ . Unfortunately same drawback with fluoride fibre remains.

**6.1.2. Raman Amplification**

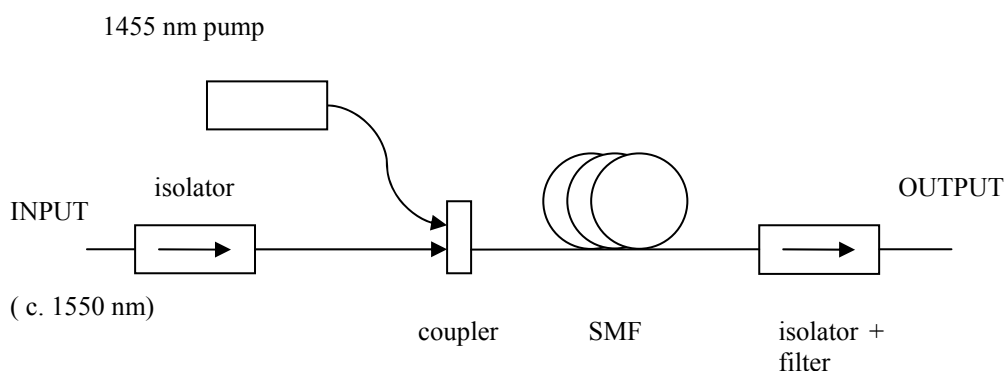
The operation principle of Raman amplifiers is based on simulated Raman scattering, which occurs in any fibre. When two different wavelengths propagate in fibre and their wavelength variation, so called Stokes shift, is circa 13 THz (corresponds about 100 nm in C band), due to fibre non-linear properties the shorter wavelength (must be powerful enough) excites electrons of fibre core to a higher energy level. Then passing photons of longer wavelength stimulate excited electrons and they drop at an intermediate energy level, releasing photons of a longer wavelength. Thus an optical amplification is reached. Operating principle is shown at Figure 20. The fibre can be co or counter or bidirectionally pumped.

**Raman OA advantages:**

- Common transmission fibre can be used as active (gain) medium.
- Bandwidth can be “tailored” (with 1 pump up to 35nm, with more pump up to 90nm).
- Usable in 1250-1650 nm regions.
- Lower NF than EDFA, can be  $\text{NF} < 1\text{ dB}$ .

**Raman OA disadvantages:**

- Lower efficiency than EDFA, thus lower gain -  $G$  in  $<10, 15>\text{ dB}$ .
- Higher inter-channel crosstalk than EDFA.
- High pump powers present in transmission fibre, circa  $<0.3, 1.3>\text{ W}$  - safety issues.



**Figure 20: Raman amplifier principle (co-pumped version)**

### 6.1.3. Semiconductor Optical Amplifiers

Operation principle of SOAs is based on conventional laser process; an active environment is composed by waveguide area sandwiched between n and p semiconductor areas. When bias voltage is connected the excitation process of electron-hole pairs takes place, then a light of a specific wavelength coupled into waveguide area causes electron-hole pairs recombination conjoined with generation of more photons with same wavelength as original signal. Thus an optical amplification is reached. Advantages and disadvantages are summarized in the two following lists.

#### SOAs advantages:

- Spectral usability in 800, 1310 and 1550 nm bands, quite wideband (40 – 80 nm).
- Gain up to  $G > 25\text{dB}$ .
- Output power up to  $P_{\text{out}} > 15\text{ dBm}$ .
- Small, compact semiconductor devices, can be easily integrated (e.g. receiver preamplifier, etc.).
- Can be used for wavelength conversion (due to cross-gain modulation phenomena).

#### SOAs disadvantages:

- Higher NF than EDFA, in range  $<7, 10> \text{ dB}$ .
- Higher cross talk than EDFA (due to four-wave mixing phenomena) makes them not suitable for DWDM usage.
- Polarization dependent devices.

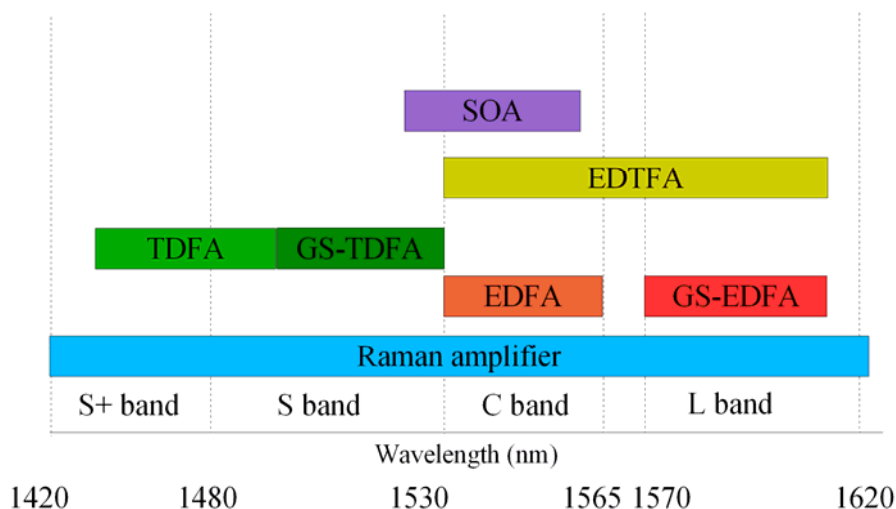
### 6.1.4. DWDM Amplifiers

The modern DWDM systems that are offering tens to thousands parallel transmission channels put on used OA additional demands. Among the most important demands belong the flat gain spectra over all spectral bands used by transmission system.

#### 6.1.4.1 Covering C, L and S bands

As demand for transmission bandwidth grows, in spite of DWDM channel spacing reduction (starting from 200 GHz to 100 GHz and to 50 GHz), the spectrum used by DWDM systems grew from C band to L band and now

is growing to S band. Such wide spectra can cover Raman OA but no single fibre OA. The Figure 21 shows OAs which are possible to use in low-loss spectral bands (C, L and S). According to this figure, it is clear that all these DWDM bands (C, L and S) can be covered with at least two different types of amplifiers (Raman, EDFA or some kind of modified version of EDFA).



**Figure 21: OAs operational wavelength ranges**

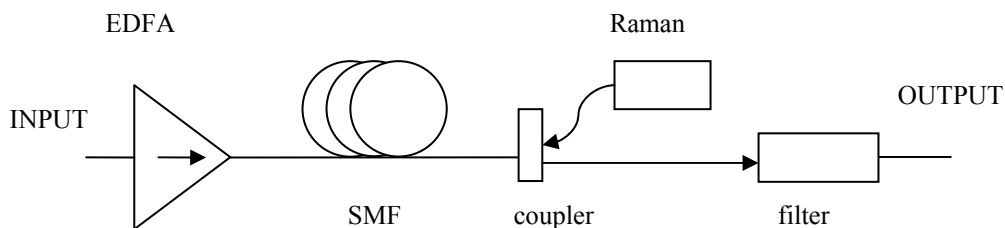
A short description of amplifiers suitable for C, L and S bands and their operating wavelength range follows:

- EDFA: Erbium Doped Fibre Amplifier (1530-1565nm)
- GS-EDFA: Gain-Shifted EDFA (1570-1610nm)
- TDFA: Thulium Doped Fluoride-based Fibre Amplifier (1450-1490nm)
- EDTFA: Tellurium-based gain-shifted TDFA (1530-1610nm)
- GS-TDFA: Gain-Shifted Thulium Doped Fibre Amplifier (1490-1530nm)
- RFA: Raman Fibre Amplifier (1420-1620nm or more as multi-arm)
- SOA: Semiconductor Optical Amplifier (1520-1560nm)

#### 6.1.4.2 Flat gain spectra

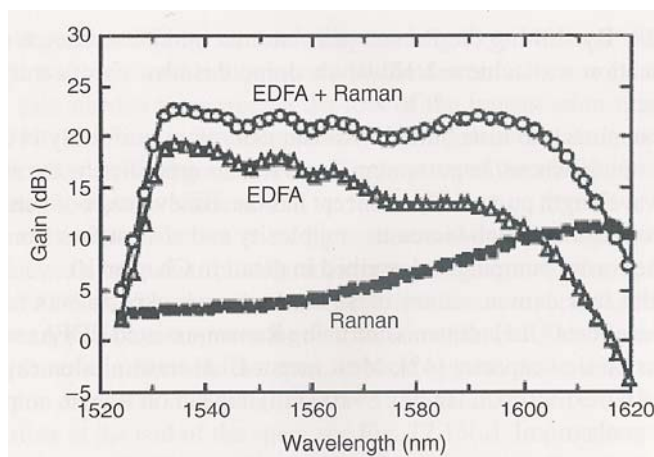
The next important requirement to DWDM OA concerns the spectral gain flatness to guarantee nearly the same gain for all the channels. Regarding Raman OAs, as already mentioned, the bandwidth (and its flatness) can be tailored easily using more pumps. The situation is worse regarding fibre OAs, as mentioned in chapter 6.1.1.1 the gain spectra of OFAs is not inherently flat and must be flattened. Flattening possibilities (3 basic approaches) are analyzed for the most popular of them, the EDFAs.

- Glass composition (F, Te glass host).
  - Single stage EDFA, silica host: bandwidth 15nm.
  - Single stage EDFA, fluoride host: bandwidth 25nm.
- Equalizers.
  - Two stage, silica or fluoride host, no gain flattening: 30nm.
  - Two stage, silica host, gain flattening: 50nm.
  - Two stage, tellurite host, gain flattening: 80nm.
- Hybrid EDFA.
  - Multi-arm - two band operation, silica host: 85nm.

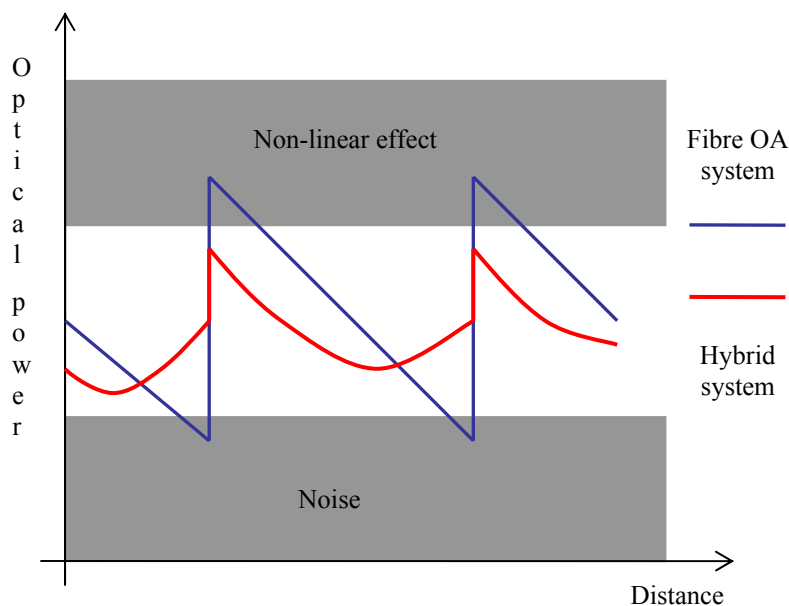


**Figure 22: Hybrid OA using EDFA and counter pumped Raman OA**

An interesting possibility to reach the flat gain is offered by hybrid EDFA-Raman OAs. In the previous picture the operational principle of the hybrid OA is shown. The following diagram illustrates the flat gain benefit of hybrid OA design. The hybrid OA also can offer lower OSNR comparing to EDFA only system, because of following reasons: a) It is not necessary to launch such high power into a fibre as in EDFA only system (smaller influence of non-linear effects). b) The signal does not drop into a noise as fast as in pure EDFA system. Situation is depicted at Figure 24.



**Figure 23: Hybrid EDFA-Raman OA gain spectra comparison [9]**



**Figure 24: Fibre OA and hybrid system comparison****6.2. Chromatic Dispersion Compensation**

All materials used in optical networks exhibit a chromatic dispersion because the speed of light is wavelength dependent (i.e. the index of refraction varies with the wavelength). The result is the times broadening of transmitted pulses called inter symbol interference (ISI), because of different spectral pulse components travelling at different speeds. This means overlapping of neighbouring pulses and difficult recovery with acceptable bit error rate (BER). Chromatic dispersion becomes critical at higher bit rates (10 Gbit/s and higher). Fortunately, chromatic dispersion can be (relatively easily) compensated because it is a deterministic phenomenon. Dispersion compensating devices are used to compensate the effects of chromatic dispersion. [9], [12]

**6.2.1. Dispersion Compensating Fibres**

- A special kind of fibre, compensates all wavelengths (the only solution for „grey“ i.e. non DWDM transmitters).
- Adds link loss, especially for long-haul applications.
- Stronger non-linear effects (due to a smaller core diameter of DCF).
- Very expensive.

**6.2.2. Fibre Bragg Gratings**

- Narrow-band elements – a stabilized DWDM laser is a must.
- „Wide-band“ FBGs available today (for 50 ITU DWDM channels).
- Suitable not only for CD compensating but for signal filtering, spectrum shaping, tuneable compensators.
- Cost effective solution.

**6.2.3. Other Methods**

Other promising methods that have been studied are Optical Phase Conjugation (OPC) and namely new-come Electronic pre-compensation techniques.

**6.2.3.1 Optical Phase Conjugation (OPC)**

- A nonlinear optical technique (sometimes called midspan spectral inversion)
- The complex conjugate of a pulse-propagation equation
- Four-wave mixing in a nonlinear medium (phase conjugators) [13]

**6.2.3.2 Electronic Pre-compensation**

- A relatively new technique

- An electrical signal is pre-distorted before converting into an optical domain
- Dispersion can be easily tuned for up to thousands kilometres of G.652 fibre [14]
- Very promising, not ready for commercial deployment yet

## 7. Single and Multi Spans Configurations for Optical Transmission Systems

As optical data signals travel in a fibre, degradation factors like fibre attenuation or chromatic dispersion start to limit the maximum fibre distances between transmitter and receiver. For very long distances, an optical signal may be so attenuated that it becomes too weak for a given receiver sensitivity and the most important transmission parameter - bit error rate (BER) - can become too high (i.e. worse than  $10^{-12}$  or even  $10^{-15}$  for some applications). It means the optical power of the optical signal must be periodically conditioned. It may happen that for very high bit rates (40 Gbit/s or even 160 Gbit/s), a signal is heavily distorted because of other linear or non-linear effects (chromatic or polarization mode dispersions or self phase modulation). The main objective is to assure that the power of the optical signal at the receiver side is greater than the sensitivity of the receiver.

A legacy solution to this problem is to use an electrical regenerator or a repeater. The regenerator extracts signals from the fibre and converts an optical signal to the electrical domain where the signal is reamplified (or retransmitted), reshaped and retimed. Electrical regenerators are hence considered as 3R devices whereas optical amplifiers 1R only (the optical signal is reamplified only). In contrast, optical amplifiers, described in paragraph 6.1, are transparent, i.e. unaware of bit rates or protocols and formats and, to some extent of the wavelength of the optical signal. Optical amplifiers can amplify many optical signals directly and simultaneously and this is a major advantage of their usage. The use of optical amplifiers in an optical network involves few problems indeed – they add noise and degrade the optical signal to noise ratio (OSNR) - and therefore the number of optical amplifiers in a cascade is limited. Optical amplifiers are used to amplify signals and compensate for optical losses (fibres, connectors, splices, and various optical components like OADMs) and to extend the optical reach of transmitters, but unfortunately, like any other amplifiers, they represent a source of additional cumulative noises – the main noise source is amplified spontaneous emission (ASE).

When an optical signal becomes too distorted and noisy, some form of 3R conditioning is needed. This signal conditioning is done electrically (even in all-optical networks) because all-optical 3R regenerators are not commercially available yet.

The most important system parameters that determine the limits of an optical transmission system are the bit rate of a channel and the modulation technique. The impact of the bit ratio and different modulation techniques on systems performance are discussed in other paragraphs of this document. For our purposes and examples discussed in this paragraph, we assume that OOK is used as a modulation technique of choice with NRZ signal format and the maximum bit rate is limited to 10 Gbit/s, unless indicated differently.

### 7.1. Single Span Solutions – *Nothing in Line (NIL)* approach

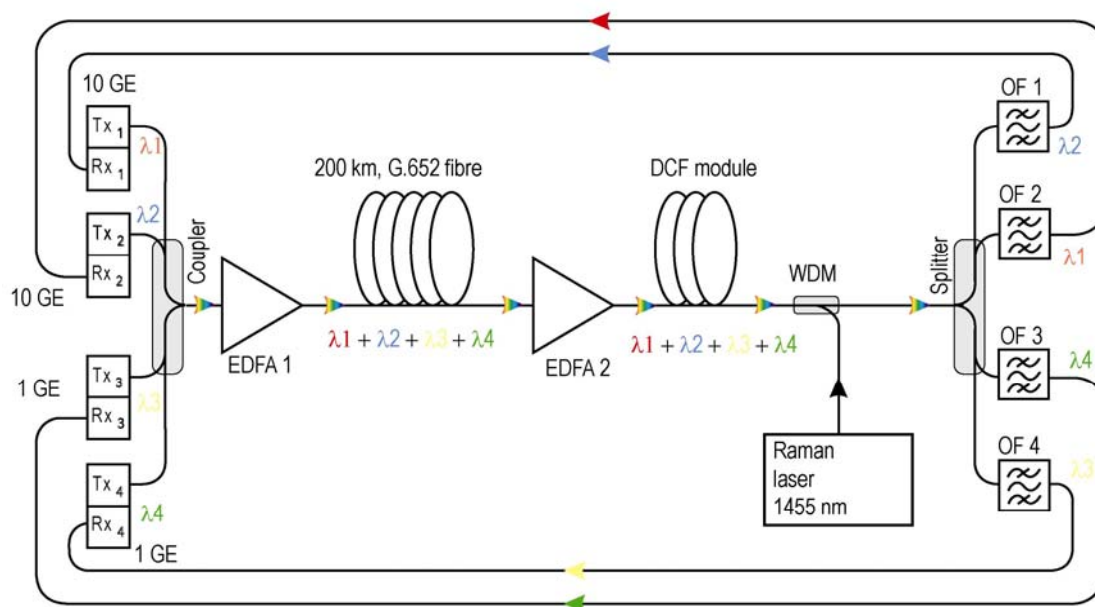
Telco operators eliminate losses of the optical links with erbium-doped fibre amplifiers (EDFAs). The EDFAs (together with dispersion compensating modules) are periodically inserted in the fibre links every 80 km to 100 km. In some cases, the deployment of in-line EDFAs is rather inconvenient. For example, in Research and Educational Networks (NREN) or Customer Empowered Fibre (CEF) networks, where dark fibres are extensively deployed, the utilization of in-line EDFAs has many drawbacks. They demand electric power supplies, increase the probability of network breakdowns and require regular maintenance in remote sites. The approach eliminating in-line equipment is called *Nothing In Line (NIL)*; sometimes terms like *repeaterless* or *hut-skipping* solutions can be found in the literature as well as in commercially available systems.

Sometimes limiting factors may be quite obvious – a fibre connection between the mainland and a coast-island is a very good example where the application of in-line amplifiers should be avoided and a NIL solution is strongly preferable.

Extending the distance limits of 10 Gbit/s non-return to zero (NRZ) data signals is therefore a really important task. If a span length is greater than the power budget of the transceivers, different amplification techniques can be used to extend the optical reach of the transmission system without deployment of any in-line equipment. EDFAs are well suited to do that because of their commercial availability, maturity and relatively low costs. In this scenario, EDFAs are typically used as a high-power amplifier (booster) and a low-noise preamplifier. An optical power launched into a fibre is limited by non-linear effects and for a single channel system by self-phase modulation (SPM) only. When the power (i.e. intensity) becomes too high, the signal starts to modulate

its own phase and this leads to spectral broadening of propagating pulses. As a consequence, the final optical reach is limited too, although EDFAs have enough power.

To further extend the reach of the system, other amplification techniques have to be used – distributed Raman amplification. When compared to EDFAs, which are lumped amplifiers, distributed Raman amplifiers (DRA) utilizes the stimulated Raman scattering effect and the silica fibre itself acts as the gain medium. The fibre can be either directionally or counter-directionally pumped (i.e. the pump light travels in the opposite direction then the data signal) and the optical reach can be extended to more than 300 km. For the counter-directional configuration, the signal is amplified where the amplification is most needed and the signal is the weakest. Consequently, where the signal is the strongest, the pump power is quite low and non-linear effects are minimized and that's the reason why this configuration is the most common. But Raman amplifiers exhibit significant cross gain modulation and have some polarization-dependence problems. Additionally, the Raman effect is quite weak in silica media and this leads to more specific and potentially dangerous safety issues. To achieve sufficient Raman amplification, pump lasers with very high output powers are needed (up to 1.5 Watts or even higher). An automatic laser shutdown (ALS) mechanism has to be implemented in all high power amplifiers with respect to international standards and norms [27], [28]. Another scattering effect – Brillouin – could be used for optical amplification but this effect in silica media is quite weak too and the gain covers a very narrow band, when compared to Raman scattering. In [29], experimental and theoretical results of 2 x 10 GE plus 2 x 1 GE WDM transmissions over 202 km of standard single-mode fibre (SSMF, G.652) are reported. All transceivers used in this experiment were non-stabilized and therefore tunable and expensive components had to be used. The guaranteed reach of 10 GE transceivers is 40 km only.



**Figure 25: Four channels over 202 km NIL setup**

With new DWDM transceivers (GBICs, SPFs, XENPAKs or XFPs), inexpensive and standardized components can be used and the results can be encouraging for operators trying to build new types of networks and to deploy new equipment not commercially available yet. For similar experiments reported in [30], the guaranteed optical reach of 40 km was extended to 252 km.

The latest results of these experiments with DWDM SDH/SONET line cards were summarized in [31] and used for building an experimental, breakable optical network called CzechLight.

The last method used to extend the optical reach utilizes remotely optically pumped amplifiers (ROPAs). Remote amplifiers are located somewhere along the transmission fibres and to excite them, a dedicated pumping fibre has to be used. These configurations seem to be quite complicated and expensive to be further studied (and deployed in the near future) within the scope of SEEFIRE project



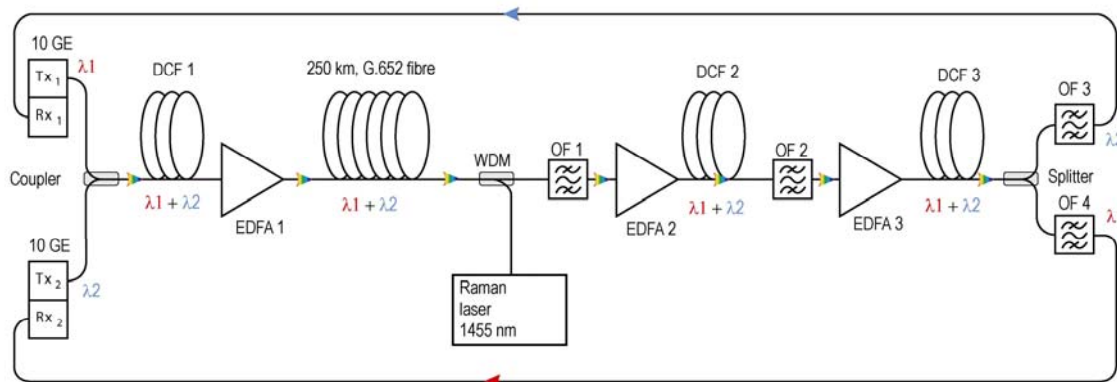


Figure 26: Two 10GE channels over 202 km NIL setup

Interface(s)	Length (km)	Attenuation (dB)	Fibre type(s)
1 x 1 GE	350	74	G.652
2 x 1 GE	325	68	G.652
1 x 2.5 G POS	300	65	G.652
1 x 10 G SDH DWDM	290	61	G.652
1 x 10 G SDH DWDM	302	64	G.652 + G.655
2 x 1 GE + 2 x 10 GE	202	43	G.652
2 x 10 GE	252	53	G.652

Table 4: CESNET NIL results

## 7.2. Multi Span Solutions

A span length can be determined by certain factors, for example when a protection, data-link switching mechanism, is implemented. We can assume that both working and protection paths use different network segments and are diversely routed through the network. A length of a backup segment can easily exceed the maximum tolerable signal to noise ratio or chromatic dispersion. As we know, chromatic dispersion (CD) can be compensated by means of various techniques so that it does not represent a major issue but OSNR is definitely a limiting factor, especially in all-optical networks. It means that NIL solutions are not suitable for these limiting factors because an optical signal is too noisy and 3R signal conditioning is required.

To provide and guarantee an unchallenged upgrade procedure from a single channel configuration (i.e. non multi-channel DWDM) to the maximum number of channels and a multi-span configuration, a system has to be designed and set properly right from the start. The situation and system design is relatively easy for a single channel configuration. The most important parameters to consider are linear effects, such as fibre attenuation, CD, PMD, receiver sensitivity and tolerance to dispersions and nonlinear effects, such as SPM. For a true multi-channel DWDM system, the design is more complicated. The system performance for a multi-channel configuration is decreased because of additional limiting factors like Cross Phase Modulation (XPM) and Four Wave Mixing (FWM).

Even the optical amplifiers (EDFA, Raman) limit the distance and performance of multi-channel DWDM optical transmission systems more than a single-channel one. That means the span length and attenuation is decreased as the number of optical amplifiers increase. The span length as a function of the number of optical amplifiers cannot be exactly calculated for every system and scenario but rather is recommended by every DWDM system vendor. If these recommendations are not available (i.e. for building of NREN or CEF

networks with equipment from different vendors), some software simulations and laboratory tests are strongly recommended before deployment.

Here are some recommendations from different vendors on the range of attenuation per span using optical amplification.

# of Spans	# of EDFAs in the Path	Worst Attenuation per Span (dB)
1	1 (1 post amp)	22 - 25
1	2 ( 1 post, 1 pre amp)	33 - 36
2	3 (1 post, 1 pre, 1 line amp)	25 - 28
3	4 (1 post, 1 pre, 2 line amps)	23 - 26
4	5 (1 post, 1 pre, 3 line amps)	21 - 26

**Table 5: Cisco Systems, ONS 15454, Multi Span examples**

System	# of Channels	Attenuation (dB)	Total Capacity (Gbit/s)	Total Length (km) for 0,22 dB/km
10 G	80	46	800	209
10 G	20	57	200	259
2.5 G	1	> 68	2.5	309

**Table 6: Marconi Corporation - Single Span examples**

System	# of Spans	Attenuation per Span (dB)	Total Attenuation (dB)	Total Length (km) for 0,22 dB/km
LH	10	22	220	1000
ELH	19	22	418	1900
ULH	37	22	814	3700

**Table 7: Marconi Corporation - Multi Span examples**

### 7.2.1. Long-haul DWDM transmission systems

Long-haul (LH), extended long-haul (ELH) and ultra long-haul (ULH) optical DWDM transmission systems represent a rather different area. Data are transmitted over thousands of kilometres and it may be quite problematic. All kinds of optical impairments discussed so far come into play and have much stronger and devastating effects on data. One of the biggest problems to solve is reducing the accumulated ASE from all cascaded optical amplifiers. One solution is to deploy DRA (sometimes together with other amplifiers in so called hybrid schemes) because of low noise figures when compared to EDFAs. Other solution to noise reduction is utilization of digital signal processing (DSP) with inverse noise filters but this application of DSP is still in a very experimental phase.

Because of very long distances, high power amplifiers are used and it means that non-linear effects are stronger than in optical networks for access and metro areas and optical signals may be severely degraded. SPM and

XPM are very common non-linearities and can be avoided when optical powers are carefully optimized and low enough to meet certain conditions. FWM can be avoided if special wavelength assignments are implemented but it means not all ITU defined channels (with fixed channel spacing) can be used. Forward Error Correction (FEC) is another technique helping the optical signals to be transmitted over longer distances. FEC adds extra bits to data and improve BER but the bit rate (and spectral width) of the signal is increased. In ULH DWDM networks, 3R signal conditioning is needed and opto-electrical regenerators are used.

Bit rates at 10 Gbit/s are standard and few vendors do offer 40 Gbit/s systems. 40 Gbit/s systems are still quite expensive and optical impairments for speeds above 10 Gbit/s are very limiting factors that degrade the system performance considerably. Not only CD, but also PMD need to be compensated at such high transmission speeds. Together with “traditional” NRZ and OOK technologies, RZ chirped RZ (CRZ) or dispersion-managed solitons modulation formats have been adopted and together with DPSK or ODB modulation techniques are used to help overcoming engineering and technical challenges at 40 Gbit/s speeds. The latest research and experimental results achieved in ULH transmissions are mentioned in chapter 5 references.

## 8. Pure Optical Networks

The concept of pure optical networking has gained a great momentum since the late 1990s. The main driver was cost reduction, by eliminating the need for optical channel ( $\lambda$ ) termination at intermediate nodes, especially when a great number of  $\lambda$ s are deployed at each fibre. Another advantage is network transparency because pure optical networks operate at layer 1 and as such they do not care about transported protocols/frames.

Pure optical networking is enabled by a new generation of devices that are able to cost-effectively switch each  $\lambda$  at the optical domain as well as to quickly reconfigure their switching matrix by deploying technologies such as Micro-Electrical Mechanical Systems (MEMS). These devices are called Optical Cross-Connects (OXC). This market seems to revive again after the hype period of the early 2000s.

### 8.1. Optical Add Drop Multiplex (OADM) technology

#### 8.1.1. Overview

Add-Drop Multiplexers (ADMs) are well known devices from the SDH/SONET world. They enable adding new channels into the aggregate line output, as well as dropping channels from the aggregate received input. SDH/SONET ADMs add and drop PDH and SDH channels, and optical ADMs (OADMs) perform this action on optical wavelengths.

#### 8.1.2. Vendors&Products

OADM for CWDM and DWDM are quite different. Because of the inherently smaller number of wavelengths CWDM OADM is simpler and cheaper than DWDM OADM. They are usually passive devices and may be sold as a close box or as a module for a simple chassis. On the other hand, DWDM OADM are much more complicated, and their products are usually modules for the big systems (like Cisco ONS 15454).

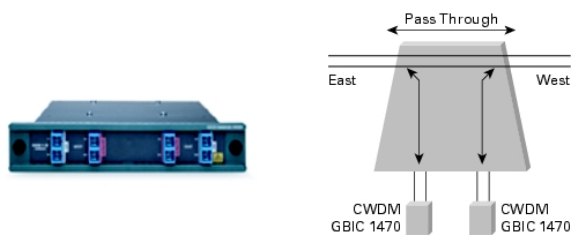
All OADM have three types of ports:

- “user” ports which add/drop new wavelengths;
- “pass” port is the input to the device, its wavelengths may be dropped or passed further;
- “network” port, is effective output from the device, which is combined from wavelengths added from the “user” ports and wavelength from the “pass” port which are not dropped.

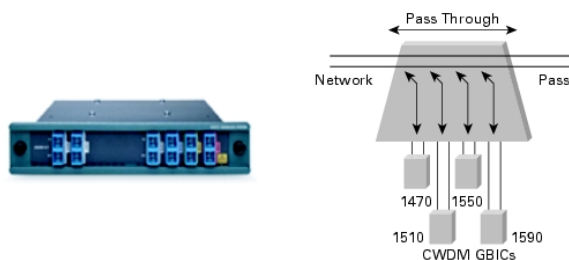
Looking at the available CWDM OADM, one can notice two main types:

- Single Wavelength Dual Channel OADM, which adds and drops single wavelength on two different ports. Examples of such devices are Cisco’s CWDM-OADM1- $\{1470,1490,1510,1530,1550,1570,1590,1610\}$  and Finisar’s FSW-OADM1- $\{47,49,51,53,55,57,59,61\}$ .
- 4-Channel OADM, which adds and drops four different wavelengths on four ports. Examples of such devices are Cisco’s CWDM-OADM4- $\{1,2\}=\$  and Finisar’s FWS-OADM-4- $\{1,2\}=\$ .

Operation of these OADM, along with pictures of Cisco’s devices, is given in the following pictures:



**Figure 27: Single wavelength dual-channel OADM**



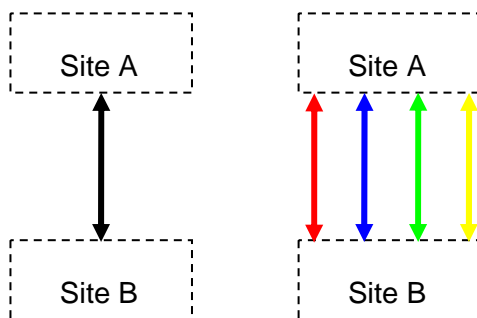
**Figure 28: 4-channel OADM**

**8.1.3. Examples of WDM Topologies**

OADMs are, along with multiplexers/demultiplexers, an integral part of the WDM solutions. We will show several WDM topologies which can be used in a variety of situations. In these examples, we will use 4-channel OADMs and 1-dual channel OADMs.

**8.1.3.1 Point-to-point**

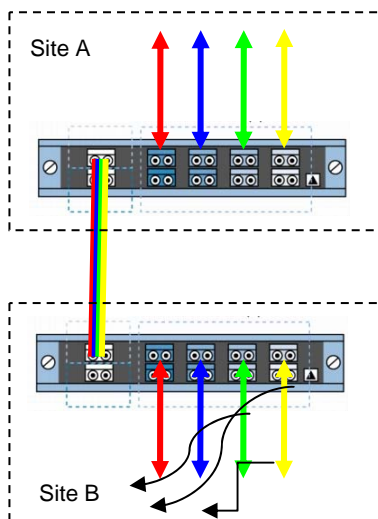
This topology is probably the simplest case of WDM application. It consists of two sites, which need to utilize several different channels (each channel has its own wavelength, depicted by the different colour). Physical (cabling) and logical (data channels) topologies are shown in the following picture:



**Figure 29: Point-to-point physical and logical topology**

Although this solution does not need an OADM, OADM can function like a simple multiplexer when the “pass” port is not connected, so the “network” port contains only aggregated signal form the user wavelengths.

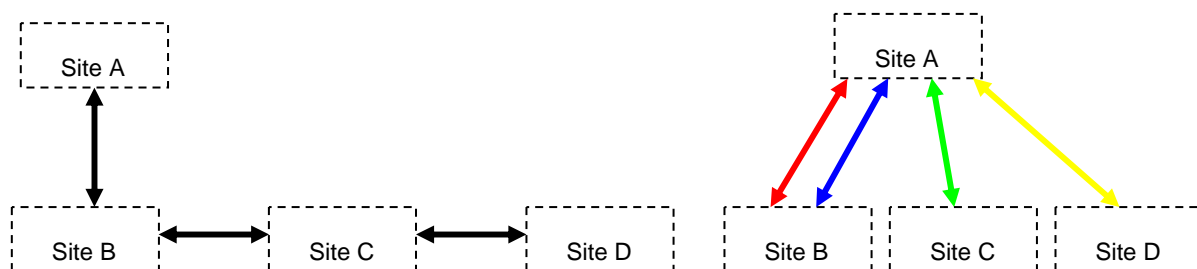
Actual data channels and their flow through the devices are shown in the following picture:



**Figure 30: Devices and channels in point-to-point application**

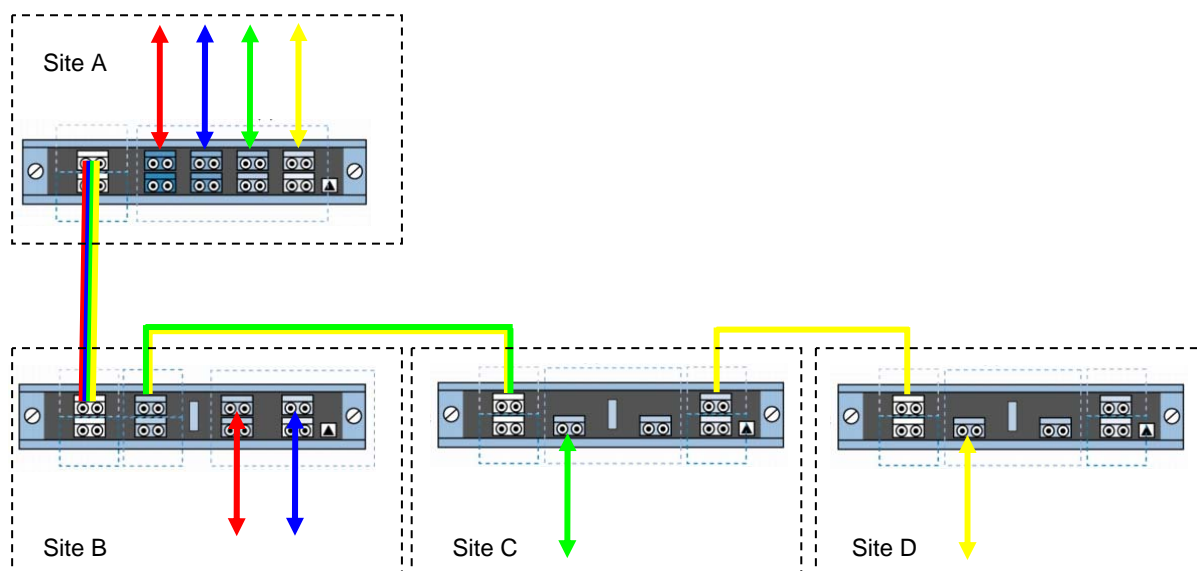
8.1.3.2 Bus

The bus topology is useful when there is a central site with preferred hub-and-spoke logical topology, but the cabling is daisy-chained:



**Figure 31: Bus physical and logical topology**

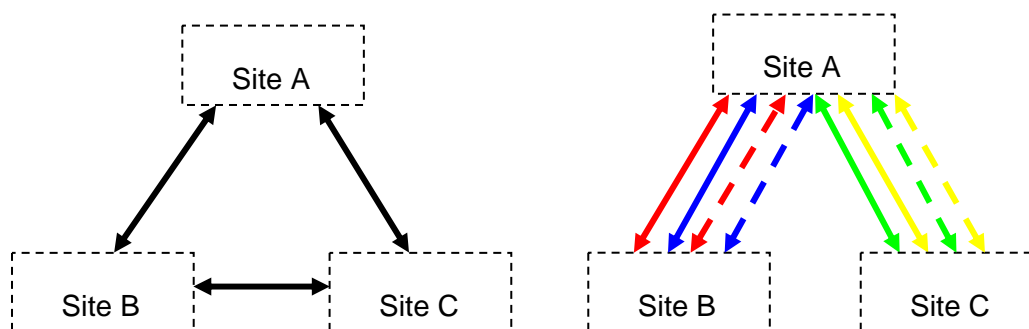
All channels start at the central site (Site A); going through sites B, C some wavelengths are dropped. If the site is dropping only a single wavelength, 1-dual channel OADM is adequate.



**Figure 32: Devices and channels in bus application**

**8.1.3.3 Protected Hub-and-spoke**

Through this topology we introduce another important concept – protected topologies with backup routes. Here we have a central site and a desired hub-and-spoke channel topology, there is a link between spoke sites, which should be used only if the primary link to the central site fails:



**Figure 33: Protected hub-and-spoke physical and logical topology**

This topology fully uses the OADM’s add and drop capability. The central site has two OADMs, one for each spoke, and each OADM multiplexes primary channels to the neighbouring spoke as well as the backup channels for the other one. Each spoke also has two OADMs, for adding/dropping both the primary and the backup connections. Note that in these examples there are two different primary connections between each hub and spoke (for example Gigabit Ethernet and Fibre Channel) requiring two backup links.

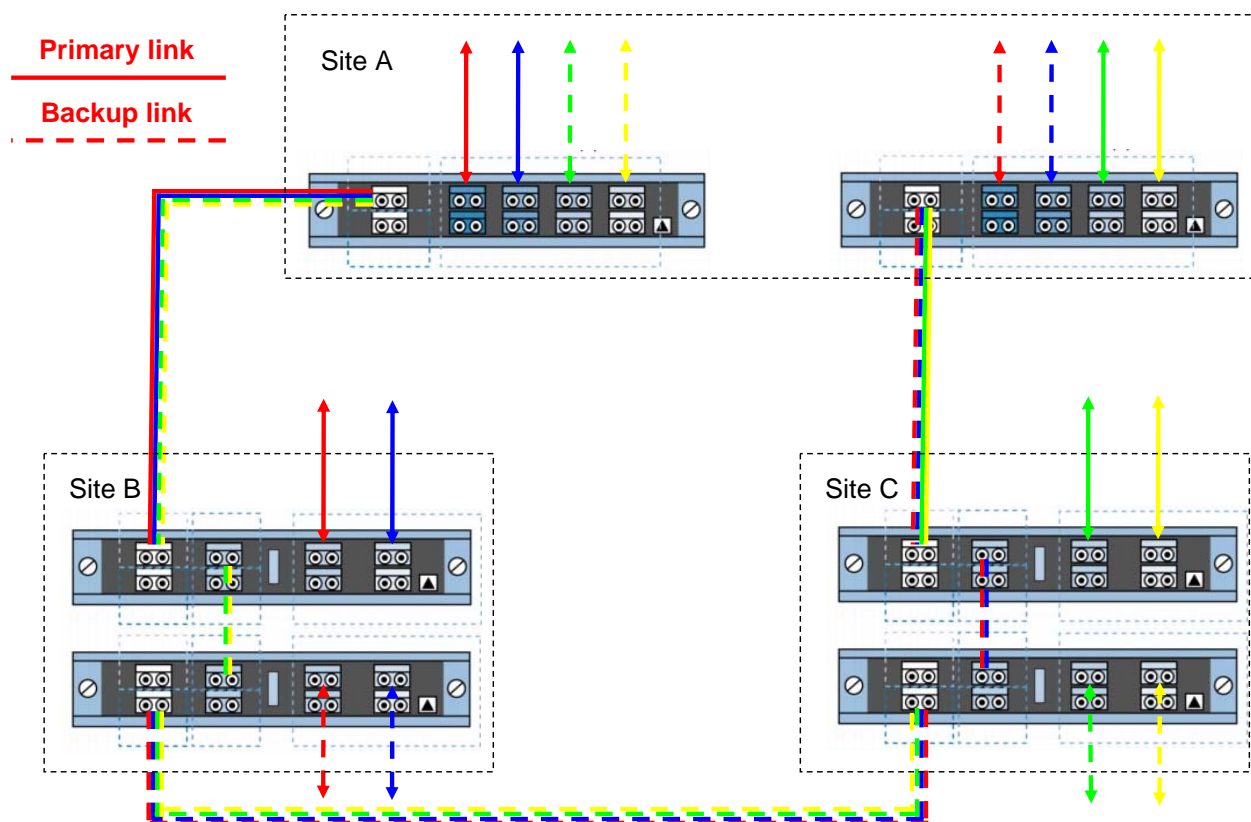


Figure 34: Devices and channels in protected hub-and-spoke application

8.1.3.4 *Ring*

The ring topology is suitable for the core part of the network. Connections can be made between any two sites on the ring:

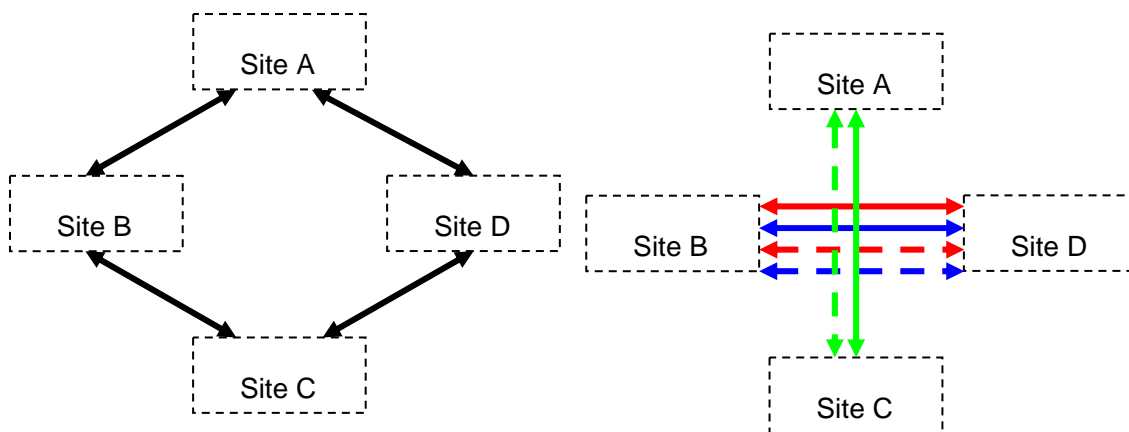


Figure 35: Ring physical and logical topology

Each site on the ring has its own OADM. If there is only a single wavelength to add/drop, 1-dual-channel OADM is sufficient. In the example, protection on the ring has been achieved by multiplexing primary connection on the clockwise ring direction, and multiplexing backup connection on the counter-clockwise direction.



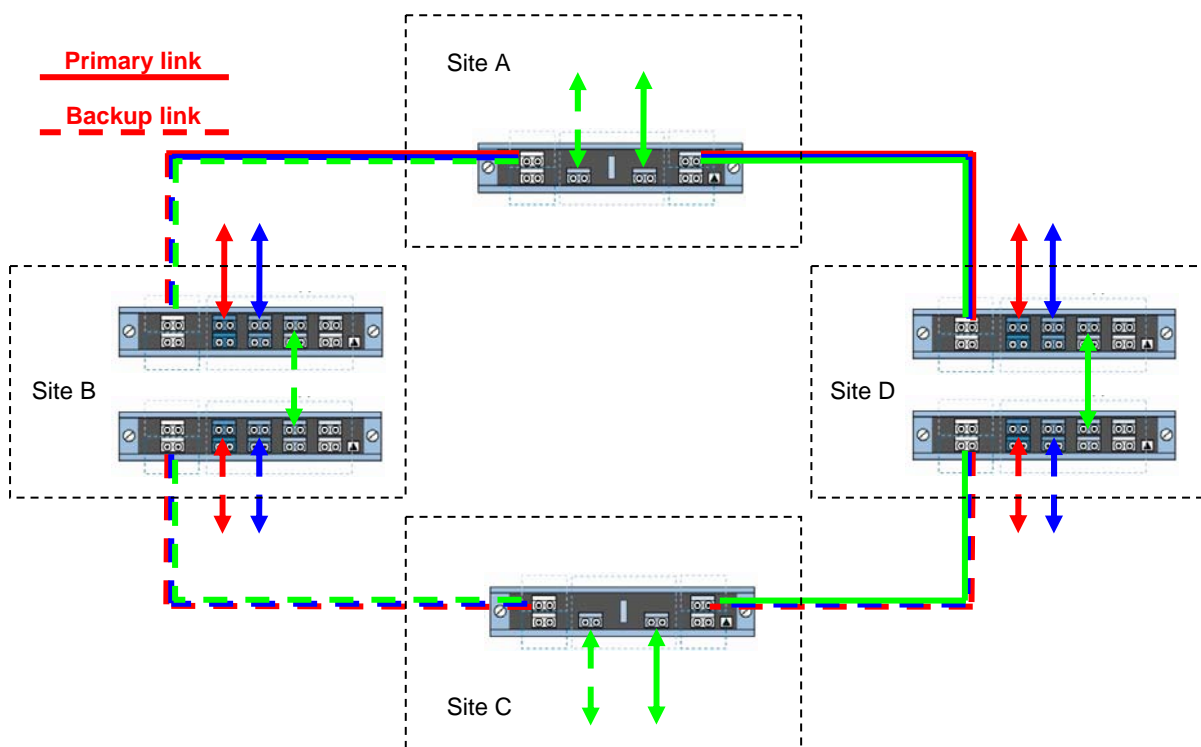


Figure 36: Devices and channels in ring application

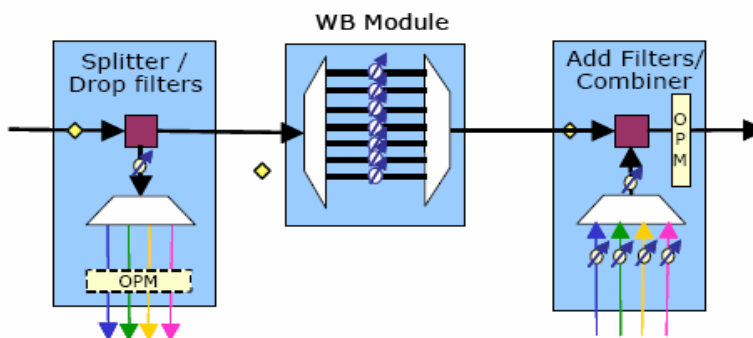
## 8.2. Reconfigurable Optical Add Drop Multiplex (ROADM) Technology

A Reconfigurable Add Drop Multiplexer (ROADM) is a remotely reconfigurable version of an Optical Add Drop Multiplexer. This enables fully automated optical transport on a per lambda basis, acceleration of service delivery and decrease in network costs [6].

Although several variations exist, there are two major architectures for implementing ROADMs: the Wavelength Blocker architecture, or 1<sup>st</sup> generation ROADM [7] which are the most widely deployed, and the Wavelength Selective Switch architecture or 2<sup>nd</sup> generation ROADM [7].

### 8.2.1. Wavelength Blocker Architecture

Figure 37 shows the Wavelength Blocker (WB) architecture. An incoming multi lambda signal is split over a drop and a pass-through path. Pass-through signal traverses a wavelength blocker module that is used to block the dropped lambdas and power balance the rest of them before the added lambdas are inserted. This is achieved by deploying Variable Optical Attenuator (VOA) modules, one for each demultiplexed lambda. VOAs are usually implemented by Micro-Electrical Mechanical Systems (MEMS) and Liquid Crystal Display (LCD) technologies [6]. WB module’s proper operation is checked by deploying per channel optical power monitor (OPM in Figure 37).



**Figure 37: The Wavelength Blocker Architecture [6]**

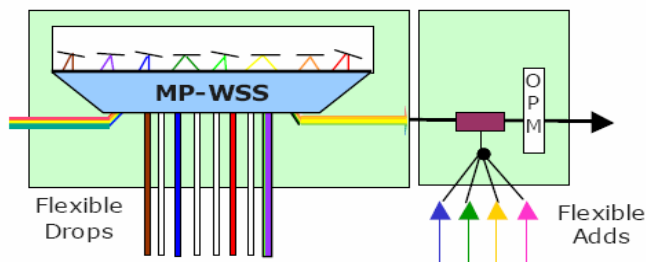
WB is a cost effective alternative for nodes with limited number of ports. However, its cost increases dramatically as port count increase [8].

The basic drawback of this architecture is that it contains lots of modules leading to increased insertion loss, limiting the achieved distances between regeneration points.

Usually filters in ROADMs of this category are not widely tuneable and can only drop predetermined lambdas. That’s why this kind of ROADM is often called “semi-reconfigurable ROADM”.

**8.2.2. Wavelength Selective Switch Architecture**

The Wavelength Selective Switch (WSS) architecture is the most recent one and it allows for full reconfigurable ROADM functionality. Figure 38 shows the WSS architecture. An incoming multi-lambda signal is directed to the WSS, which is capable of redirecting a lambda to one or more output ports. Note that the WSS includes VOAs for power control. WSSs are typically implemented by Micro-Electrical Mechanical Systems (MEMS).



**Figure 38: Wavelength Selective Switch architecture [6]**

The WSS architecture includes fewer optical components than the WB architecture resulting in smaller insertion loss. In addition, split losses are avoided at the receive side and the same demultiplexer is used for both the drop and pass-through lambdas.

## 9. Optical Measurement

In practice, from a NREN point of view, measurement of the optical path is only conducted in the cases of path acceptance and path operation and maintenance. This chapter concerns single-mode fibres only. Issues concerning multi modal fibres (like proper exciting, modal distribution and so on) are not included here.

The following are parameters and among the most frequently measured

- Attenuation
- Optical Return Loss (ORL)
- Chromatic Dispersion (CD)
- Polarization Modal Dispersion (PMD)

Attenuation represents the most important and the most often measured value. The attenuation measurement will be discussed in section 9.1. The attenuation of the whole path, cable section, splice, connector, etc. is measured. An ORL of spot disruption e.g. of connector junction, is measured usually, eventually an ORL of the whole path. The influence of both dispersions (PMD and CD) grows with the data transmission speed, e.g. for 2.5 Gbit/s speeds their influence is only marginal, whereas for 10 Gbit/s speeds and higher their influence over transmission is crucial. It is not possible to predict the Fibre PMD (due to its stochastic nature), which therefore must be measured. On other hand CD ratio is given by fibre type. The measurement of PMD and CD will be discussed in section 9.2.

### 9.1. Attenuation

The attenuation of optical fibre for a particular wavelength  $\lambda$  is given by the following equation:

$$A(\lambda) = 10 \log (P_1 / P_2) \quad (\text{dB})$$

Where  $P_1$  is the reference value of the optical power (W) and  $P_2$  (W) is its measured value.

Alternatively for powers in dBm:

$$A(\lambda) = L_1 - L_2 \quad (\text{dB})$$

Where  $L_1$  (dBm) is reference value of the optical power and  $L_2$  (dBm) is its measured value.

The specific attenuation of a fibre for a particular wavelength  $\lambda$  is given by:

$$\alpha(\lambda) = A(\lambda) / l \quad (\text{dB/km})$$

Where  $l$  (km) is the length of the fibre.

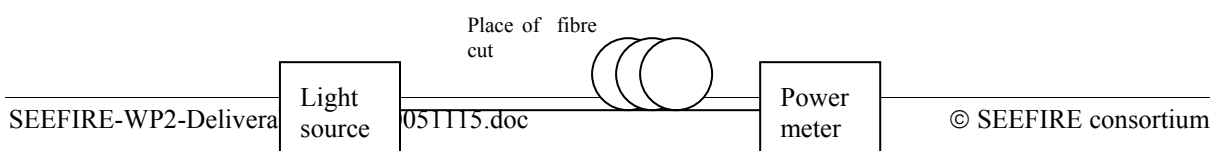
For measurement of the whole fibre attenuation, there are three methods recommended by the International Electrotechnical Commission (IEC):

- **Cut-back** method (FOTP 78)
- Method of **insertion loss** (FOTP 53)
- Method using **backscattering** (OTDR) (FOTP 8)

The first two methods belong to direct transmission methods. These methods require a stable (time and temperature stability) light source of the desired wavelength and optical power meter.

#### 9.1.1. Cut-back Method

This method is recommended as a reference one because of its high sensitivity. The accuracy of the method can be up to 0,01dB [16]. But unfortunately, as shown in Figure 39, this method is disruptive.. After  $P_2$  measurement, the fibre must be cut about 2 meters after light source and reference value  $P_1$  is measured.



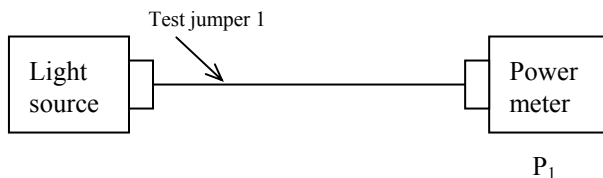


**Figure 39: Cut-back method**

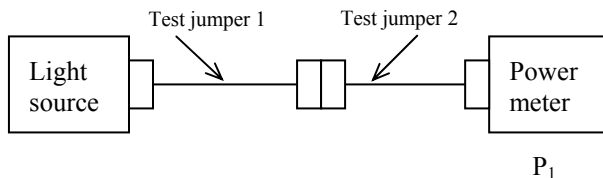
**9.1.2. Insertion Loss Method**

The insertion loss method takes place in two steps too. The reference value of  $P_1$  is determined in the first step. Concerning  $P_1$  determination, three different procedures exist:

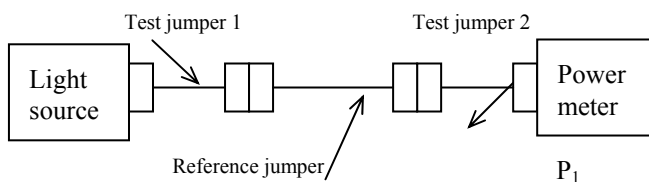
- a) One reference module method - Figure 40.
- b) Two references module method - Figure 41.
- c) Three references module method - Figure 42.



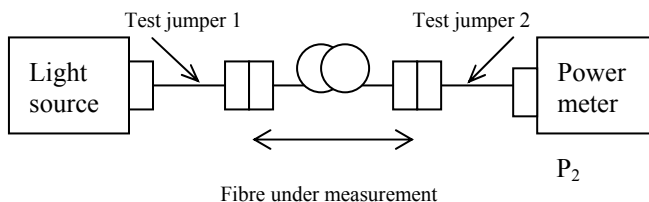
**Figure 40: Insertion loss method with one reference module -  $P_1$  measurement**



**Figure 41: Insertion loss method with two references module -  $P_1$  measurement**



**Figure 42: Insertion loss method with three references module -  $P_1$  measurement**



**Figure 43: Insertion loss method -  $P_2$  measurement**

The procedure of  $P_2$  determination is the same for all three cases. The procedure a) is the most used; the resulting attenuation is given by the sum of the attenuation of the measured fibre and two times the connector attenuation. In case b) the resulting attenuation is given by the sum of the attenuation of the measured fibre and

of the connector attenuation. Finally, in case c) the resulting attenuation equals the attenuation of the measured fibre only.

In the assessment of the whole path attenuation process it is important to determine the optical path attenuation limit. For a particular wavelength  $\lambda$ , the attenuation limit is given by:

$$A(\lambda) = l \cdot \alpha(\lambda) + n_1 \cdot A_s + n_2 \cdot A_c$$

Where  $l$  (km) is the length of the path,  $\alpha(\lambda)$  is the specific attenuation limit (dB/km),  $n_1$  is the number of splices in the path,  $A_s$  is the splice attenuation limit (dB),  $n_2$  is the number of connectors in path and  $A_c$  is the connector attenuation limit (dB). The specific attenuation limit is given by the optical fibre manufacturer specification and fibre type. The splice attenuation limit is indicated typically as 0.08 dB [16] or 0.2 dB [17]. The connector attenuation limit is given by the connector type and is indicated generally as 0.5 dB [16] or more specifically as 0.2-0.25 dB [17].

### 9.1.3. Optical Time Domain Reflectometry (OTDR)

This method uses two important phenomena occurring when an optical pulse is propagating in the fibre: Fresnel reflection on spot disruptions and Rayleigh back scattering in fibre. The OTDR method belongs to the group of one-sided methods; the transmitting and receiving parts are located into one device. The measuring device is connected to one side of the path, while the opposite side is disconnected. The transmitter sends short power pulses during the measurement. The receiver measures the time interval between pulse transmission and detects back scattered or reflected parts of the pulse from different path places. By knowing the refracting index of the fibre, the distance can be computed from the measured time. A series of (“dummy”) fibre must be used due to minimal measurable value of delay. The duration of the measuring pulse affects the accuracy and reach of the method: with increasing pulse width the reach increases, whereas the accuracy decreases.

The method can also be used for whole path attenuation determination (average of measurement performed from both sides), and offers a lot of useful possibilities to determine:

- Fibre length, position of splices, connector junctions (refraction index of fibre must be known)
- Attenuation of splices and connector junctions
- Attenuation of fibre sections (specific attenuation), attenuation homogeneity
- An ORL of spot disruption (e.g. of connector junction) and of the whole path.

OTDR represents a very useful tool for locating faulty or dirty connectors and excess bends. The determination of excess bends requires measurement to be done for two different wavelengths; reflectometers usually works on the following wavelength combination: 1310/1550nm or 1310/1550/1625nm (1625nm is necessary for fibres designed not for 1310 nm operation, e.g G.655 fibre).

## 9.2. Chromatic Dispersion and Polarization Mode Dispersion

Chromatic dispersion and related problems are described in section 6.2. PMD will be briefly described here. PMD is a stochastic phenomenon caused by fibre imperfections (stresses during the manufacturing processes and installation and consequent geometry deformations) and the result is that one part of the pulse (“a fast axis”) travels faster than the other one “a slow axis”. This means that PMD is constantly changing over time and wavelengths and therefore can not be easily compensated.

Second-order PMD is related to the variation of PMD with wavelengths but is not as important as PMD (but can become a limiting factor for very high bit rates and very long fibre links).

From our experience, PMD is critical for bit rates higher than 10 Gbit/s; PMD-related problems for 10 Gbit/s speeds are still being discussed.

There are three CD and three PMD measurement methods standardized by TIA/EIA (Telecommunications Industry Association/ Electronic Industries Alliance). [15]

### **9.2.1. Chromatic Dispersion Measurement**

- The Modulated Phase-Shift Method (FOTP 169)
- The Differential Phase-Shift Method (FOTP 175)

Both phase-shift methods are very accurate, measurement can be done through optical amplifiers, but they are expensive.

- The Spectral Group Delay Measurement in the Time Domain (FOTP 168)

This method is still accurate enough, although no measurement through optical amplifiers is possible.

### **9.2.2. Polarization Mode Dispersion Measurement**

- The Fixed Analyzer Method (FOTP 113)
- The Interferometric Method (FOTP 124)

These are well known methods but with limited troubleshooting capabilities.

- The Jones Matrix Method (FOTP 122)

The last method is known as the “Golden Standard”, it is accurate and allows for precise troubleshooting along the fibre link.

## 10. Evaluation and Experiences

Optical pluggable transceivers represent essential elements of modern data transmission systems. Exactly their pluggability allows deployment of the most suitable transceivers and future adaptation or upgrade induced by newer technologies. Pluggable transceivers are deployed not only on client sides but also on link sides of transmission systems. This chapter brings the synopsis and parameters comparison of data network pluggable transceivers, including examples of devices used in SEE NREN with detailed parameters description. The chapter deals with older but still very often used gigabit transceivers but also with newer ten gigabit transceivers.

### 10.1. Gigabit Pluggable Transceivers

Gigabit Pluggable Transceivers come in two different types: GBIC (Gigabit Interface Converter) and SFP (Small Form-factor Pluggable). Both types have the same application, but different technical characteristics. Both of these are standardized through the SFF committee [18].

These modules are hot-swappable, which means that they can be inserted or removed to and from the switch without turning off the power.

In the following chapters we will describe the basics about each type, and show the product range for three vendors: Cisco, Agilent and Finisar. Cisco is chosen because its switching and routing equipment is already deployed in the majority of PoP in SEE NRENs, while Agilent and Finisar are some of the most important real manufactures of gigabit pluggable transceivers, which is explained later in Chapter 10.1.1.2.

#### 10.1.1. GBIC

##### 10.1.1.1 Overview

The GBIC standard was originally brought in 1995 in order to standardize transceiver for Fibre Channel application. Since 1995, it has been modified to support other technologies as Gigabit Ethernet (in 1000BASE-SX/LX/ZX specifications as well as the CWDM variants) and SONET. Although single GBIC is usually made for single technology, there are GBICs (such as Finisar FTR-1319-3D) which support both Fibre Channel and the Gigabit Ethernet. It should be noted that these technologies slightly differ in the line rate: Fibre Channel works at 1.0625 Gbit/s, and Gigabit Ethernet works at 1.25 Gbit/s. Although GBICs are usually made for speed around 1 Gbit/s, some vendors have 2.5 Gbit/s GBICs, for 2X Fibre Channel operation.

The current GBIC specification is v5.5 from September 2000 (document SFF-8053); this can be found on [19]. At the host side, a GBIC transceiver has 20-pin connector SCA-2, specified in SFF-8073 standard. On the network side, the transceivers have several types of connectors: DSC for fibre optic cables, RJ-45 for 1000BASE-T.

Newer GBICs, conforming to specification v5.4 Annex D, have an E<sup>2</sup>PROM readable by the host device. Such a specification defines the first 64 bytes as the base ID fields and the next 32 bytes as the extended ID fields. Some of the fields found in E<sup>2</sup>PROM are:

- Type of serial transceiver (ID:0)
- Connector (ID:2)
- Code for electronic and optical compatibility (IDs:3-7)
- Link length supported for 9/125 µm fibre, in km (ID:14)
- Link length supported for 9/125 µm fibre, in 100m units (ID:15)
- Link length supported for 50/125 µm fibre, in 10m units (ID:16)
- Link length supported for 62,5/125 µm fibre, in 10m units (ID:17)
- Vendor name (IDs:20-35)
- Vendor OUI (IDs:37-39)

From these fields, the host device (e.g. switch) can easily find out the characteristics of the GBIC at a certain port, not only the technical characteristics but also the administrative ones. This feature enabled vendors to restrict the GBICs that can be used in their equipment, by disabling the port in which the “foreign” GBIC is found. The current vendor policy is shown in the following table (from “GBIC Directions & Standard Support”, by Dave Wodelet at Nanog 2003 and from vendors own sources).

Vendor	Current GBIC policy
Cisco Systems	Allows only self-produced GBICs for 1000BASE-T and CWDM; Allows any GBIC for 1000BASE-SX/LX/ZX
Juniper Networks	Allows any GBIC
3Com	Allows only self-produced GBICs
Extreme	Allows only self-produced GBICs

**Table 8: Policy of GBIC vendors**

10.1.1.2 Vendors and Products

GBICs are largely manufactured as an OEM product. There are only a few real manufacturers and some of them are Agilent, Finisar and IBM/JDS Uniphase. For the full list of the GBIC manufacturers, the reader should refer to the market research report [32].

Cisco Systems offers only Gigabit Ethernet GBICs. A list of the fibre GBICs products and their most important characteristics is given in the following table:

P/N	Type	Wavelength	Fibre	Core Size	Modal Bandwidth	Distance	Transmit power (Max/Min)	Receive power (Max/Min)
WS-G5484	1000BASE-SX	850	MMF	62.5	160	220 m	-4/-9.5	0/-17
			MMF	62.5	200	275 m		
			MMF	50	400	500 m		
			MMF	50	500	550 m		
WS-G5486	1000BASE-LX/LH	1300	MMF	62.5	500	550 m	-3/-9.5	-3/-19
			MMF	50	400	550 m		
			MMF	50	500	550 m		
			SMF	9/10	N/A	10 km		
WS-G5487	1000BASE-ZX	1550	SMF	9/10	N/A	70-100 km	0/-3	-3/-23
CWDM-GBIC-<WL> <sup>1</sup>	CWDM	<WL>	SMF	9/10	N/A	Unspec	+5/+1	-7/-29

<sup>1</sup> <WL> 1470, 1490,1510,1530,1550, 1570, 1590, 1610 nm

**Table 9: Cisco Systems GBICs**



One of the most interesting things about Cisco and some other switch vendors is the policy of refusing GBIC from other vendors (third-party GBICs) in their devices. GBICs for 1000BASE-SX/LX/ZX (product numbers WS-G5484/WS-G5486/WS-G5487) do not have E<sup>2</sup>PROM, and therefore the switch cannot check their origin. Since GBICs for Cisco devices are very popular in the market, there are lots of different options for buying such a GBIC. The most conservative option is buying “original” Cisco GBIC, which would be very likely manufactured by Agilent. There are various products named like “Agilent OEM” priced slightly less than “original”, and “OEM” which can cost 30-50% less. However, Cisco policy states that using other GBIC than the original one will not be supported by TAC or covered by SMARTnet guarantee.

Certain Cisco Catalyst switches have the “show controller ethernet-controller <interface> phy” command which displays some variables from the GBIC’s E<sup>2</sup>PROM. It can be found that even GBICs sold as “original” Cisco GBICs differ in the Vendor Name field:

```
cisco3550-rect#show controllers ethernet-controller gi0/2 phy
General GBIC Registers:
Identifier           : 01
Connector           : 01
Transceiver         : 00 00 00 01 00 00 00 00
Encoding            : 01
BR_Nominal          : 0D
Vendor Name         : AGILENT
Vendor Part Number  : QFBR-568
Vendor Revision     : 30 30 30 30
Vendor Serial Number : 0111061852591489

cisco3550-rect#show controllers ethernet-controller gi0/4 phy
General GBIC Registers:
Identifier           : 01
Connector           : 01
Transceiver         : 00 00 00 01 00 00 00 00
Encoding            : 01
BR_Nominal          : 0D
Vendor Name         : CISCO-AGILENT
Vendor Part Number  : QFBR-568
Vendor Revision     : 30 30 30 30
Vendor Serial Number : A53773189

cisco3550pwr#sh controllers ethernet-controller gi0/1 phy
General GBIC Registers:
Identifier           : 01
Connector           : 00
Transceiver         : 00 00 00 08 00 00 00 00
Encoding            : 01
BR_Nominal          : 00
Vendor Name         : CISCO@SYSTEMS
Vendor Part Number  : WS-G5483
Vendor Revision     : 20 20 20 20
Vendor Serial Number : FHH0749TOMK
```

The list of Agilent fibre GBICs and their most important characteristics is given in the following table:

P/N	Type	Wavelength	Fibre	Core Size	Modal Bandwidth	Distance	Transmit power (Max/Min)	Receive power (Max/Min)
HFBR-5601	1000BASE-SX	850	MMF	62.5	Unspec	220 m	-4/-9.5	0/-17
			MMF	50	Unspec	500 m		
HFCT-5611	1000BASE-LX	1310	MMF	62.5	Unspec	550 m	-3/-11.5	-3/-20
			MMF	50	Unspec	550 m		
			SMF	9/10	N/A	10 km	-3/-9.5	

**Table 10: Agilent GBICs**

The list of Finisar fibre GBICs and their most important characteristics is given in the following table:

P/N	Type	Wavelength	Fibre	Core Size	Modal Bandwidth	Distance	Transmit power (Max/Min)	Receive power (Max/Min)
FTR-8519-3D	1000BASE-SX	850	MMF	62.5	200	275 m	-3/-9.5	Unspec/-19
			MMF	50	500	550 m		
FTR-1319-3D	1000BASE-LX	1310	MMF	62.5	200	275 m	-3/-9	-3/-19
			MMF	50	500	550 m		
			SMF	9/10	N/A	10 km		
FTR-1419	100BASE-ZX	1310	SMF	9/10	N/A	40 km	+3/-2	-1/-23
FTR-1519-V2	100BASE-ZX	1550	SMF	9/10	N/A	80 km	+4/0	-1/-24

**Table 11: Finisar GBICs**

For other vendors, it is interesting to mention Optoway's GBS-72120 which has receiver sensitivity -32 dBm and possible link budget at the same value, resulting in 120 km specified range.

## 10.1.2. SFP

### 10.1.2.1 Overview

The current SFP specification is from September 2000 (document SFF-8074); this can be found on [20]. At the host side, the SFP transceiver also has 20-pin connector. At the network side, transceivers usually have LC or MT-RJ connectors. Because of the transceiver dimension, DSC cannot be used with SFP.

The most important differences between GBIC and SFP are:

- Smaller width than GBIC's (13.7 mm instead of 30.48 mm) which allows greater port density;
- Support for 4Gbit/s application;
- Transceiver diagnostic.
- Support for SONET.

One of the most important new features in SFP technology (also found in some newer GBICs like Cisco's CWDM and Finisar's FTR1419 and FTR-1519-V2) is the possibility of reading diagnostics from the transceiver (specified in the SFF-8472 document). There are currently five parameters that can be read from transceiver (two more can be added in the future):

- Internally measured transceiver temperature
- Internally measured transceiver supplied voltage
- Measured TX bias current
- Measured TX output power
- Measured RX received optical power

Also, it is important to note that in 2003 the European Parliament issued a directive, 2002/95/EC ([http://europa.eu.int/eur-lex/pri/en/oj/dat/2003/l\\_037/l\\_03720030213en00190023.pdf](http://europa.eu.int/eur-lex/pri/en/oj/dat/2003/l_037/l_03720030213en00190023.pdf)), which deals with the Restriction of certain Hazardous Substances (RoHS). This directive, which will be effective from July 1st 2006, restricts all electrical and electronic products having six hazardous substances (lead, mercury, cadmium,

hexavalent chromium, polybrominated biphenyls, polybrominated diphenyl ethers). Some vendors like Finisar are already making RoHS-compliant products, and others will probably follow.

### 10.1.2.2 Vendors and Products

Cisco Systems offers only Gigabit Ethernet and SONET SFPs. New models of 1000BASE-SX/LX/ZX (SFP-GE-S/L/Z), unidirectional GBIC and SONET SFPs support SFF-8274 diagnostics (Digital Optical Monitoring – DOM). A list of fibre SFP products and their most important characteristics is given in the following tables:

Cisco Gigabit Ethernet SFPs:

P/N	Type	Wavelength	Fibre	Core Size	Modal Bandwidth	Distance	Transmit power (Max/Min)	Receive power (Max/Min)
GLC-SX-MM SFP-GE-S	1000BASE-SX	850	MMF	62.5	160	220 m	-4/-9.5	0/-17
			MMF	62.5	200	275 m		
			MMF	50	400	500 m		
			MMF	50	500	550 m		
GLC-LH-SM SFP-GE-L	1000BASE-LX/LH	1300	MMF	62.5	500	550 m	-3/-9.5	-3/-20
			MMF	50	400	550 m		
			MMF	50	500	550 m		
			SMF	9/10	N/A	10 km		
GLC-ZX-SM SFP-GE-Z	100BASE-ZX	1550	SMF	9/10	N/A	70-100 km	+5/0	0/-23 <sup>1</sup>
GLC-BX-U	100BASE-BX10-U	1310 (Transmit) 1490 (Receive)	SMF	9/10	N/A	10 km	3/-9	3/-19.5
GLC-BX-D	100BASE-BX10-D	1490 (Transmit) 1310 (Receive)	SMF	9/10	N/A	10 km	3/-9	3/-19.5
CWDM-SFP-<WL> <sup>1</sup>	CWDM	<WL>	SMF	9/10	N/A	Unspec	+5/0	-7/-28

**Table 12: Cisco GE SFPs**

Cisco SONET POS/ATM SFPs:

P/N	Type	Wavelength	Fibre	Distance	Transmit power (Max/Min)	Receive power (Max/Min)
SFP-OC3-MM	OC-3/STM-1 Multi-mode	1270 to 1380	MMF	2 km	-14/-19	-5/-30
SFP-OC3-SR	OC-3/STM-1 Short Range	1260 to 1360	SMF	2 km	-8/-15	-8/-23
SFP-OC3-IR1	OC-3/STM-1 Intermediate-Reach	1261 to 1360	SMF	15 km	-8/-15	-8/-28
SFP-OC3-LR1	OC-3/STM-1 Long-Reach (40 km)	1263 to 1360	SMF	40 km	0/-5	-10/-34

SFP-OC3-LR2	OC-3/STM-1 Reach (80 km)	Long-	1480 to 1580	SMF	80 km	0/-5	-10/-34
SFP-OC12-MM	OC-12/STM-4 Multi-mode	Multi-	1270 to 1380	MMF	0.5 km	-14/-20	-6/-26
SFP-OC12-SR	OC-12/STM-4 Range	Short	1261 to 1360	SMF	2 km	-8/-15	-8/-23
SFP-OC12-IR1	OC-12/STM-4 Intermediate-Reach		1293 to 1334	SMF	15 km	-8/-15	-8/-28
SFP-OC12-LR1	OC-12/STM-4 Reach (40 km)	Long-	1280 to 1335	SMF	40 km	+2/-3	-8/-28
SFP-OC12-LR2	OC-12/STM-4 Reach (80 km)	Long-	1480 to 1580	SMF	80 km	+2/-3	-8/-28
SFP-OC48-SR	OC-48/STM-16 Range	Short	1266 to 1360	SMF	2 km	-3/-10	-3/-18
SFP-OC48-IR1	OC-48/STM-16 Intermediate-Reach		1260 to 1360	SMF	15 km	0/-5	-0/-18
SFP-OC48-LR2	OC-48/STM-16 Reach (80 km)	Long-	1500 to 1580	SMF	80 km	+3/-2	-9/-28

**Table 13: Cisco SONET POS/ATM SFPs**

All Cisco SFPs are checked by Cisco switches. A switch computes a security code and compares it to the one found in SFP E<sup>2</sup>PROM. If they are not equal, the switch will put the port in error-disabled state. Some of the error messages that may be encountered in these situations are:

- Message “GBIC\_SECURITY\_UNIQUE-3-DUPLICATE\_GBIC: GBIC interface <interface> is a duplicate of GBIC interface <interface>”; this message means that two Cisco compliant SFPs have the same Security Code. Some no-name vendors make Cisco-compliant SFPs by copying the same E<sup>2</sup>PROM contents to all SFP modules. Since the switch checks for such situation, only one of them can be used in a single device;
- Message “GBIC\_SECURITY\_CRYPT-4-ID\_MISMATCH: Identification check failed for GBIC interface [chars]”, means that the switch cannot read the Vendor Name from the E<sup>2</sup>PROM;
- Message “GBIC\_SECURITY\_CRYPT-4-UNRECOGNIZED\_VENDOR: GBIC interface [chars] manufactured by an unrecognized vendor”, means that the Vendor Name from the SFP E<sup>2</sup>PROM does not match any of the Cisco-approved vendors;
- Message “GBIC\_SECURITY\_CRYPT-4-VN\_DATA\_CRC\_ERROR: GBIC interface [chars] has bad crc”, means that the computed CRC is not the same as in the SFP E<sup>2</sup>PROM;

Agilent Gigabit Ethernet SFPs:

P/N	Type	Wavelength	Fibre	Core Size	Modal Bandwidth	Distance	Transmit power (Max/Min)	Receive power (Max/Min)
HFBR-5710L/LP	1000BASE-SX	850	MMF	62.5	Unspec	275 m	0/-9.5	0/-17
			MMF	50	Unspec	550 m		
HFCT-5710L/LP	1000BASE-LX	1310	MMF	62.5	Unspec	550 m	-3/-9.5	-3/-20
			MMF	50	Unspec	550 m		
			SMF	9/10	N/A	10 km		

**Table 14: Agilent GE SFPs**

Finisar has a very wide range of SFPs. For example, for a single 1000BASE-SX application, there are six potential models (plain, plain + RoHS compliant, plain + RoHS compliant + extended temperature, plain + RoHS compliant + industrial temperature, 4Gbit/s plain, 4Gbit/s plain + RoHS compliant).

Finisar Gigabit Ethernet SFPs:

P/N	Type	Wavelength	Fibre	Core Size	Modal Bandwidth	Distance	Transmit power (Max/Min)	Receive power (Max/Min)
FTRJ8519P1WNL	1000BASE-SX	850	MMF	62.5	Unspec	300 m	-4/-9.5	Unspec/-18
			MMF	50	Unspec	500 m		
FTRJ1419P1xCL	1000BASE-LX	1310	SMF	9/10	N/A	55 km	+5/0	Unspec/-22
FTRJ1519P1xCL	Gigabit Ethernet	1550	SMF	9/10	N/A	88 km	+5/0	Unspec/-22
FTRJ1619P1xCL	Gigabit Ethernet	1550	SMF	9/10	N/A	112 km	+5/0	Unspec/-30

**Table 15: Finisar GE SFPs**

Interesting notes:

- 1000BASE-LX GBIC have stronger transmitters (up to 5 dBm) than those from competing vendors, allowing them 55 km distance at 1310 nm 1000BASE-LX (usually to 10 km)
- According to the specification, the model FTRJ1619P1xCL has -35 dB link budget allowing for 112 km application!

## 10.2. Ten Gigabit Pluggable Transceivers (XFP, XENPAK)

### 10.2.1. XENPAK Fibre Optic Transceiver Module

The XENPAK fibre optic transceiver module specification is based on a so called Multi Source Agreement (MSA) initiated by Agilent Technologies and Agere Systems. The aim of the MSA is to create a widely accepted, interchangeable IEEE 802.3ae conformant 10 Gigabit Ethernet transceiver module specification, which enables transceivers and equipment manufacturers to follow commonly accepted guidelines when planning and producing 10GE capable switches and routers. The greatest technical advantage of this approach is to allow 10GE users to interchange XENPAK transceiver modules between different equipment regardless of the manufacturer company. From a different perspective, this approach gives 10GE providers the possibility to choose the XENPAK supplier, which supports market competition and makes 10GE more economical to deploy.

The MSA was publicly announced on March 12<sup>th</sup>, 2001 and the first revision of the MSA XENPAK specification was released on May 7<sup>th</sup>, 2001. The document is freely available at the official XENPAK web portal [21]. The MSA agreement is open for any organizations/manufacturers to join in support of the XENPAK 10GE modules.

Currently, the MSA agreement has more than 20 members from optical transceiver and telecom equipment manufacturers. The most important members of the XENPAK MSA are:

- Agere Systems
- Agilent Technologies
- Optillion
- Mitsubishi Electric
- Nortel Networks
- Intel Corporation
- Extreme Networks
- NEC Corporation
- Hitachi Cable, Ltd.



The MSA itself covers the physical, optical, electrical and management specification of the XENPAK 10GE modules. The main technical aspects of the modules:

- Industry standard 70-pin electrical interface to accommodate to router/switch line cards
- SC duplex fibre optic connector
- Hot pluggable
- All physical mediums covered by IEEE 802.3ae 10GE are supported (see a short summary below)

In the picture below, two pieces of XENPAK modules can be seen.



**Figure 44: XENPAK interface physical layout [21]**

In the following table, IEEE 802.3ae 10GE physical mediums are detailed:

ID	Cable type	Distance	Note
10GBase-CX4	Copper, 24 gauge wire	min. 15-20m	4x Infiniband connector
10GBase-SR	MMF fibre @ 850nm	26-300m	Distance depends on cable type
10GBase-LR	G.652 SMF fibre @ 1310nm	min. 10km	
10GBase-ER	G.652 SMF fibre @ 1550nm	min. 40km	
10GBase-LX4	MMF or SMF fibre @ 1310nm	300m/10km	WWDM, see below.
10GBase-SW 10GBase-LW 10GBase-EW			Lower speed 10GE (9.95Gbit/s) for OC-192/STM-64
10GBase-T	Cat 5e UTP/Cat 6 UTP/Cat7 STP	22-40m/55-100m/100m	Being standardized, to be finished in mid-2006. No such XENPAK yet.

**Table 16: IEEE 802.3ae 10GE physical mediums**

WWDM (Wide Wavelength Division Multiplexing) was introduced by the IEEE when CWDM became a subject of investigations for resolving dispersion problems of the 10 GE technology. The purpose of WWDM is to extend the lifetime of multi-mode fibres deployed in campuses and company premises by enabling 10GE to be transferred using multi-mode fibres. WWDM specifies four WDM channels in the 1310nm window and the basic idea here is to split up a 10GE flow to four separate parts, each using different lower data rate (3.125Gbit/s) modulated wavelength, thus facilitating multi-mode fibres to transmit 10GE with satisfying dispersion parameters.

Another newly introduced technology in the 10GE standard is OC-192/STM-64 compatibility. This technology allows a provider to easily map its metro 10GE streams into STS/STM virtual containers. As 10G SONET/SDH is capable of transmitting 9.95Gbit/s, the related compatible 10GE interface (10GBase-SW/LW/EW) data rate is lowered to make mapping enable into SONET/SDH virtual containers.

In the tables below, XENPAK products of some dominant vendors can be seen together with their most important technical parameters.

P/N	Type	Wavelength	Cable Type	Core Size	Modal Bandwidth	Distance	Transmit power (Max/Min)	Receive power (Max/Min)
XENPAK-10GB-CX4	10GBASE-CX4	-	copper	-	-	15 m	-	-
XENPAK-10GB-LX4	10GBASE-LX4 (4x wavelength lane)	1310 nm	MMF	62.5	500	300 m	-0.5/- per lane	-0.5/-14.4 per lane
				50.0	400	240 m		
				50.0	500	300 m		
XENPAK-10GB-SR	10GBASE-SR	850 nm	MMF	62.5	160	26 m	-1.0/-7.3	-1.0/-9.9
				62.5	200	33 m		
				50.0	400	66 m		
				50.0	500	82 m		
				50.0	2000	300 m		
XENPAK-10GB-LR	10GBASE-LR	1310 nm	SMF	G.652	-	10 km	+0.5/-8.2	+0.5/-14.4
XENPAK-10GB-ER	10GBASE-ER	1550 nm	SMF	G.652	-	40 km	+4.0/-4.7	-1.0/-15.8

**Table 17: Cisco XENPAKs**

In addition to the interfaces listed in the table above, DWDM frequency grid compatible versions of Cisco XENPAK 10GBASE-ER DWDM are also available. These XENPAKs use a fixed 100GHz channel spacing operating on No. 21-59 ITU-T DWDM channels (between 1530.33-1560.61nm).

P/N	Type	Wavelength	Cable Type	Core Size	Modal Bandwidth	Distance	Transmit power (Max/Min)	Receive power (Max/Min)
HFCT-701XB	10GBASE-LR	1310 nm	SMF	G.652	-	10 km	+0.5/-8.2	-/-12.6

**Table 18: Agilent XENPAKs**

### 10.2.2. XFP Fibre Optic Transceiver Module

The XFP interface is a small form factor, hot pluggable, cost effective and protocol unaware, 10Gbit/s fibre optic transceiver. The XFP is also designed under a Multi Source Agreement (MSA) as well as the XENPAK (see above). This cooperation was established on 4<sup>th</sup> of March, 2002 and the first MSA document was released in July, same year. The XFP MSA is open for any organizations and manufacturers to join and the MSA specification document is freely available at [22]. The XFP cooperation has nearly 50 members already, the most important market players are:

- Agilent Technologies
- Broadcom Corporation
- Intel Corporation
- LSI Logic Corporation
- NEC Corporation
- Xilinx, Inc.



The main goal of the XFP MSA is to create the specification of a small size 10Gbit/s module, which includes the full description of the corresponding cage hardware, electrical and optical interfaces. Apart from the small size, the most important attribute of an XFP module is its protocol unawareness, which enables the module to implement several different layer 2 datalink protocols using different framing and data rate. These protocols are:

- OC192/STM-64 at 9.95 Gbit/s
- 10 Gigabit Fibre Channel at 10.5 Gbit/s
- G.709 Optical Transport Network at 10.7 Gbit/s
- 10 Gigabit Ethernet at 10.3 Gbit/s

In the picture below an XFP module can be seen with an optical cable attached. The relation between an XFP and a XENPAK module can be best compared to the relation between an SFP and a GBIC module. The XFP is often referred to as “next generation optical transceiver module” indicating its future practical importance. Because of the complexity of the XFP hardware (small size, multiple rate, low power consumption, etc.) it is the least mature of all current 10G transponder technologies. Its main advantage over all the other MSAs (XENPAK, X2 and XPAK) is its small size and low power consumption. The size of the XFP allows accommodation of 16 10Gbit/s ports on a 19” rack size switch or router card. According to market experts it is likely that XFP will be first deployed in the fibre channel switch market.



**Figure 45: XFP interface physical layout**

Please note that all the 10Gbit/s MSAs (XENPAK, XPAK, X2 and XFP) are simply an agreement on the physical, mechanical and thermal characteristics of hot pluggable, interchangeable fibre optic transceiver modules. This agreement does not affect in any way the implementation of layer 2 transmission protocol standards. This means that it is possible to link a XENPAK and an XFP module implementing e.g. 10GBase-LR Ethernet protocol.

The tables below contain relevant information on some vendors’ XFP products. Please note that manufacturers have just started introducing XFP transceivers in the market, this is the reason behind the short portfolio.

P/N	Type	Wavelength	Cable Type	Core Size	Modal Bandwidth	Distance	Transmit power (Max/Min)	Receive power (Max/Min)
HFCT-721XPD	10GBASE-LR	1310 nm	SMF	G.652	-	10 km	+0.5/-8.2	+0.5/-14.4
	1200-SM-LL-L 10G FC					2 km		

**Table 19: Agilent XFPs**

P/N	Type	Wavelength	Cable Type	Core Size	Modal Bandwidth	Distance	Transmit power (Max/Min)	Receive power (Max/Min)
XFP-10GLR-OC192SR	10GBASE-LR	1310 nm	SMF	G.652	-	10 km	+0.5/-8.2	+0.5/-14.4
	OC-192/STM-64					2 km	-1.0/-6.0	-1.0/-11.0

**Table 20: Cisco XFPs**

P/N	Type	Wavelength	Cable Type	Core Size	Modal Bandwidth	Distance	Transmit power (Max/Min)	Receive power (Max/Min)
FTRX-1411D3	10GBASE-LR/LW	1310 nm	SMF	G.652	-	10 km	+0.5/-	+0.5/-12.6
	1200-SM-LL-L 10G FC							
FTRX-1411M3	10GBASE-LR/LW	1310nm	SMF	G.652	-	10km	-1.0/-6.0	+0.5/-14.4
	SONET OC-192 / SDH STM 64							
	1200-SM-LL-L 10G FC							

**Table 21: Finisar XFPs**

P/N	Type	Wavelength	Cable Type	Core Size	Modal Bandwidth	Distance	Transmit power (Max/Min)	Receive power (Max/Min)
XFP-10GD-SX	10GBASE-SR	850 nm	MMF		-	300 m	-1.0/-7.0	-/-11.0
	10G FC							
	SONET OC-192							
	SDH STM-64							
	10G FC							
XFP-10GD-LR	10GBASE-LR	1310 nm	SMF		-	10 km	-1.0/-6.0	-/-13.0
	SONET OC-192							
	SDH STM-64							
	10G FC							
XFP-10GD-IR2	10GBASE-ER	1550 nm	SMF		-	40 km	+2.0/-1.0	-/-16.0
	SONET OC-192							
	SDH STM-64							
	10G FC							

**Table 22: MRV XFPs**

## 10.3. The Rest of Ten Gigabit Transceivers

This chapter begins with 300-pin MSA transceivers, the predecessors of XENPAK, and continues with XENPAK successors, the XPAK and X2 MSAs.

### 10.3.1. 300 Pin MSA

A first 300-pin MSA specification was released on April 16th, 2001 and the latest specification is available at [23]. Among important MSA members the following companies can be found:

- Agere Systems
- Agilent
- Alcatel Optronics
- Ericsson Optoelectronics AB
- ExceLight
- Fujitsu Quantum Devices
- JDS Uniphase
- Mitsubishi Electric
- NEC
- Nortel Networks
- OpNext

The 300-pin MSA, the oldest 10 Gbit/s MSA, defines fixed (non pluggable) transceivers. To ensure compatibility with older interface integrated circuits, the 300-pin MSA can convert a 10Gbit/s serial optical signal to 16 parallel 622 Mbit/s electrical signals. The MSA allows to accommodate a lot of hardware, such as lasers and photo-detectors, with high-speed integrated circuits to perform functions such as clock synthesis, clock recovery and multiplexing and demultiplexing of those 16 622 Mbit/s channels. This is possible because of large size and big power dissipation (see also 10.4), which allow vendors to produce hi-tech transceivers such as DWDM or very long reach in an easy way.

This group has also defined 40 Gbit/s 300-pin MSA already.

### 10.3.2. XPAK and X2 MSA

The XPAK MSA is the next step in MSA evolution after XENPAK. Unfortunately, the XPAK group web pages [24] are unavailable recently. Initial specification was announced by:

- Infineon Technologies
- Intel
- Picolight

The primary goal of the XPAK MSA was to specify a XAUI transponder that could be used on a PCI server card, as XENPAK transponders are too large for this application. To achieve faster and low-risk design the XPAK MSA reuses the XAUI interface. The MSA defines two heights: low profile, which are PCI compliant; and tall profile for use in more thermally demanding applications.

A SFI-4 phase-2 interface in place of the XAUI interface was also adopted in the XPAK specification. The SFI-4 phase-2 specification extends the XAUI interface to support non-Ethernet applications such as Sonet/SDH and 10-Gigabit Fibre Channel. So far, there are no transponders announced that support this interface.

The tables below provide a short overview of some vendors’ XPAK products:

P/N	Type	Wavelength	Cable Type	Core Size	Modal Bandwidth	Distance	Transmit power (Max/Min)	Receive power (Max/Min)
V23833-G2005-A101	10GBASE-SR	850 nm	MMF	62.5	160	26 m	-1.0/-3.0	-1.0/-7.5
				62.5	200	33 m		
				50.0	400	66 m		
				50.0	500	82 m		
				50.0	2000	300 m		
V23833-G6104-A001	10GBASE-LR	1310 nm	SMF	G.652	-	10 km	0.5/-6.2	0.5/-10.3

**Table 23: Finisar XPAKs**

P/N	Type	Wavelength	Cable Type	Core Size	Modal Bandwidth	Distance	Transmit power (Max/Min)	Receive power (Max/Min)
TRP10GVP2007	10GBASE-SR	850 nm	MMF	62.5	160	26 m	-1.0/-3.0	-1.0/-7.5
				62.5	200	33 m		
				50.0	400	66 m		
				50.0	500	82 m		
				50.0	2000	300 m		
TRP10GDP0307	10GBASE-LR	1310 nm	SMF	G.652	-	10 km	-1.0/-6.0	+0.5/-10.3

**Table 24: Merge Optics XPAKs**

The X2 MSA was formed in July 2002 and the latest specification is available at [25]. Among important MSA members both component suppliers and transceiver vendors can be found:

- Agere Systems
- Agilent Technologies
- JDS Uniphase
- Mitsubishi Electric
- NEC,
- OpNext
- Optillion
- Tyco Electronics

The X2 MSA is a direct competitor to XPAK. It also supports 10-Gigabit Ethernet as well as Sonet OC192 and 10-Gbit/s Fibre Channel with SFI-4 phase-2. While the XPAK MSA was defined primarily for PCI servers, the X2 MSA was defined to replace XENPAK in the Ethernet-switch market.

The tables below provide a short overview of some vendors’ X2 products:

P/N	Type	Wavelength	Cable Type	Core Size	Modal Bandwidth	Distance	Transmit power (Max/Min)	Receive power (Max/Min)
X2-10GB-CX4	10GBASE-CX4	-	coppe r	-	-	15 m	-	-
X2-10GB-LX4	10GBASE-LX4 (4x wavelength lane)	1269 - 1355 nm	MMF	62.5	500	300 m	-0.5/- per lane	-0.5/-14.4 per lane
				50.0	400	240 m		
				50.0	500	300 m		
XENPAK-10GB-SR	10GBASE-SR	850 nm	MMF	62.5	160	26 m	-1.0/-7.3	-1.0/-9.9
				62.5	200	33 m		
				50.0	400	66 m		
				50.0	500	82 m		
				50.0	2000	300 m		
XENPAK-10GB-LR	10GBASE-LR	1310 nm	SMF	G.652	-	10 km	+0.5/-8.2	+0.5/-14.4

**Table 25: Cisco X2s**

P/N	Type	Wavelength	Cable Type	Core Size	Modal Bandwidth	Distance	Transmit power (Max/Min)	Receive power (Max/Min)
V23833-E60x4-A101	10GBASE-SR	850 nm	MMF	50.0		300 m		

**Table 26: Finisar X2s**

P/N	Type	Wavelength	Cable Type	Core Size	Modal Bandwidth	Distance	Transmit power (Max/Min)	Receive power (Max/Min)
TRP10GDP0903	10GBASE-LX4 (4x wavelength lane)	1275-1350 nm	MMF	62.5	500	300 m	-0.5/- per lane	-0.5/-15.4 per lane
				50.0	400	240 m		
				50.0	500	300 m		
			SMF	G.652	-	10 km		
TRP10GVP2003	10GBASE-SR	850 nm	MMF	62.5	160	26 m	-1.0/-3.0	-1.0/-7.5
				62.5	200	33 m		
				50.0	400	66 m		
				50.0	500	82 m		
				50.0	2000	300 m		
TRP10GDP0303	10GBASE-LR	1310 nm	SMF	G.652	-	10 km	-1.0/-6.0	+0.5/-10.3
TRP10GEP3003	10GBASE-ER	1550 nm	SMF	G.652	-	40 km	+4.0/-4.7	0.0/-11.3

**Table 27: Merge Optics X2s**

XPAK and X2 transceivers were initially focused on shorter-reach 10km links (comprising 80% of 10 GE port applications) and second-generation applications that do not need XENPAK’s thermal capacity. Some vendors have announced XPAK and X2 products; however they never started fabrication due to the telecom bubble burst. At present vendors seem to prefer XFP modules to XPAK and X2 because of their higher integration and lower power dissipation.

**10.4. Brief 10Gbit/s MSAs Comparison**

The table below provides a short comparison of particular MSA physical dimensions, power dissipations and interfaces. Source [26].

MSA	Connectors	Interface	Maximum power	Length, inches	Width, inches	Height, inches	Relative area %
300-pin	pigtails	SFI-4	14W	3 – 4	2 – 3.5	0.53	89 – 208%
XENPAK	SC	XAUI	6W / 10W (1550)	4.8	1.4	0.7	100%
XPAK	SC	XAUI	4W	3	1.56	0.39 – 0.88	70%
X2	LC/SC	XAUI	4W	3.5	1.4	0.43 – 1.14	73%
XFP	LC	XFI	1.5W, 2.5W or 3.5W	3	0.7	0.33	31%

**Table 28: 10 Gbit MSAs comparison**

## References

- [1] “International Standardization Activities on Optical Interfaces”, Masahito Tomizawa and Akira Hirano and Shigeki Ishibashi and Takeshi Sakamoto, 2003.
- [2] “Evolution of the standardization of optical transport systems within the ITU-T”, Cascelli S. and Beltrame D., 2001.
- [3] “Fibre Optics Handbook: Fibre, Devices, and Systems for Optical Communications”, Michael Bass and Eric W. Van Stryland, McGraw-Hill, 2002
- [4] “Optical Network Design and Implementation”, Vivek Alwayn, Cisco Press, 2004.
- [5] “Fibre-Optic Technology”, Web ProForum Tutorials, [www.iec.org](http://www.iec.org), 2005.
- [6] “The Dynamic Network: Managing Bandwidth and Content on Demand at the Optical Level”, Gaylord Hart and Zouheir Mansourati, SCTE Conference on Emerging Technologies, 2004.
- [7] “Strategies for Metro/Regional Optical Networks”, Brian Pratt, CEF Conference, Prague, 2005.
- [8] “MEMS fabrics in shape for the ROADMs ahead”, John Auyeung, LightWave Magazine, November 2004.
- [9] Agrawal G.P., „Fibre-Optic Communications Systems“, 2002.
- [10] Ramaswami R., Sivarijan K.N., „Optical Networks“, 2nd edition, 2002.
- [11] Kartalopoulos S. V., „DWDM Networks, Devices and Technology“, 2003.
- [12] EXFO, „Guide to WDM Technology Testing“, 2nd edition, 2000.
- [13] ECOC 2004 proceedings
- [14] OFC 2005 proceedings
- [15] <http://www.tiaonline.org>
- [16] Hajek M., Kucharski M. ”Measurement of optical cable paths”, MIKROKOM, 2004.
- [17] “Testing solutions for new fibre optics”, Optical Test and Calibration Ltd., <http://www.fia-online.co.uk/pdf/Presentation/L3410.pdf>, 2000
- [18] <http://www.sffcommittee.org>
- [19] <ftp://ftp.seagate.com/sff/SFF-8053.PDF>
- [20] <ftp://ftp.seagate.com/sff/SFF-8074.PDF>
- [21] <http://www.xenpak.org>
- [22] <http://www.xfpmsa.org>
- [23] <http://www.300pinmsa.org>
- [24] <http://www.xpak.org>
- [25] <http://www.x2msa.org>
- [26] “10-GigE Transponders: Update”, Light Reading, <http://www.lightreading.com>, 2003
- [27] EN 60825-2:2004
- [28] IEC 60825-2:2004
- [29] Karásek, M. - Peterka, P. - Radil, J., „202 km repeaterless transmission of 2 x10 GE plus 2 x 1 GE channels over standard single-mode fibre.“ In: Optics Communications 235, 2004, pp. 269-274.
- [30] Karásek, M. - Peterka, P. - Radil, J., „Transmission of 2 x 10 GE channels over 252 km without in-line EDFA.“ In: ONDM 2005, Milano, Italy, pp. 55-58, 2005, ISBN: 0-7803-8956-5.



- 
- [31] Karásek, M. - Radil, J. - Vojtěch, J., Optical amplifiers in CzechLight and CESNET2.” In: CEF workshop, Praha, Czech Republic, 2005.
- [32] Dave Wodelet, GBIC Interface Directions & Standard Support, NANOG 2003, <http://www.nanog.org/mtg-0310/pdf/wodelet.pdf>

## Acronyms

10 GE	<i>10 Gigabit Ethernet</i>
ALS	<i>Automatic Laser Shutdown</i>
ASE	<i>Amplified Spontaneous Emission</i>
BERT	<i>Bit Error Rate Tester</i>
CD	<i>Chromatic Dispersion</i>
CEF	<i>Customer Empowered Fibre</i>
CS-RZ	<i>Carrier suppressed RZ</i>
CWDM	<i>Coarse Wavelength Division Multiplexing</i>
DCF	<i>Dispersion Compensating Fibre</i>
DPSK	<i>Differential Phase Shift Keying</i>
DRA	<i>Distributed Raman Amplifier</i>
DRAGON	<i>DiRect Access to Geophysics On the Net</i>
DSP	<i>Digital Signal Processing</i>
DWDM	<i>Dense Wavelength Division Multiplexing</i>
E2E	<i>End to End</i>
EDFA	<i>Erbium Doped Fibre Amplifier</i>
ELH	<i>Extended Long-Haul</i>
FBG	<i>Fibre Bragg Grating</i>
FPGA	<i>Field Programmable Gate Array</i>
FTTx	<i>Fibre To The x (Curb, Home, Building, etc.)</i>
FWM	<i>Four Wave Mixing</i>
GBIC	<i>Gigabit Interface Converter</i>
GFP	<i>Generic Framing Procedure</i>
GFP-F	<i>Generic Framing Procedure, Framed</i>
GFP-T	<i>Generic Framing Procedure, Transparent</i>
GMPLS	<i>Generalized Multi-protocol Label Switching</i>
GSM	<i>Global System for Mobile Communications</i>
HOPI	<i>Hybrid Optical and Packet Infrastructure</i>
ISP	<i>Internet Service Provider</i>
ITU	<i>International Telecommunication Union</i>
LAN PHY	<i>LAN PHYsical layer device</i>
LCAS	<i>Link Capacity Adjustment Scheme</i>
LH	<i>Long-Haul</i>
MEMS	<i>Micro Electro-Mechanical Systems</i>
MIB	<i>Management Information Base</i>
MSA	<i>Multi Source Agreement</i>
MUPBED	<i>Multi-Partner European Test Beds</i>

---

NF	<i>Noise Figure</i>
NIL	<i>Nothing in Line</i>
NLR	<i>National Lambda Rail</i>
NRZ	<i>Non Return to Zero</i>
OA	<i>Optical Amplifier</i>
OADM	<i>Optical Add Drop Multiplexer</i>
ODB	<i>Optical Duo Binary</i>
OEO	<i>Optical-Electrical-Optical</i>
OIF	<i>Optical Internetworking Forum</i>
OOB	<i>Out of band</i>
OSNR	<i>Optical Signal to Noise Ratio</i>
OTDM	<i>Optical Time Division Multiplexing</i>
OTDR	<i>Optical Time Domain Reflect meter</i>
OTN	<i>Optical Transport Network</i>
OXC	<i>Optical Cross Connect</i>
PCI-X	<i>Peripheral Component Interconnect - Extended</i>
PDFA	<i>Praseodymium Doped Fibre Amplifier</i>
PMD	<i>Physical Medium Dependent</i>
PON	<i>Passive Optical Network</i>
PoP	<i>Point of Presence</i>
PSTN	<i>Public Switched Telephone Network</i>
PTE	<i>Path Terminating Equipment</i>
RI	<i>Refractive Index</i>
ROADM	<i>Reconfigurable Optical Add Drop Multiplexer</i>
RZ	<i>Return to Zero</i>
SDH	<i>Synchronous Digital Hierarchy</i>
SFP	<i>Small Form Factor Pluggable Transceiver</i>
SNMP	<i>Simple Network Management Protocol</i>
SOA	<i>Semiconductor Optical Amplifier</i>
SONET	<i>Synchronous Optical NETwork</i>
SPM	<i>Self Phase Modulation</i>
UCLP	<i>User Controlled Light-path Provisioning</i>
ULH	<i>Ultra Long-Haul</i>
VCAT	<i>Virtual Concatenation</i>
VCG	<i>Virtual Concatenation Group</i>
VLAN	<i>Virtual LAN</i>
VPLS	<i>Virtual Private LAN services</i>
VPN	<i>Virtual Private Network</i>
WAN	<i>Wide Area Network</i>

---

WAN PHY	<i>WAN PHYsical layer device</i>
WDM	<i>Wavelength Division Multiplexing</i>
XENPACK	<i>10 Gigabit Ethernet Pluggable Transceiver</i>
XFP	<i>10 Gigabit Small Form Factor Pluggable Transceiver</i>
XPM	<i>Cross Phase Modulation</i>