



# Optical networks—the electro-optic reality

Andrzej Jajszczyk\*

*Department of Telecommunications, AGH University of Science and Technology, Mickiewicza 30, 30-059 Kraków, Poland*

Received 19 July 2004; received in revised form 29 October 2004; accepted 8 November 2004

Available online 2 December 2004

---

## Abstract

A general overview of the current status and future trends in optical networking is given. Special attention is given to the coexistence of optical and electronic technologies in telecommunications networks. After reviewing the advantages of both technologies, their use in different network areas is discussed. A critical survey of current and new transport technologies in optical core and metropolitan networks is given, including SDH/SONET and its enhancements, OTN, RPR, and Ethernet. The current status and prospects for photonic switching are briefly presented. The paper is concluded with an overview of the control plane for optical transport networks.

© 2004 Elsevier B.V. All rights reserved.

*Keywords:* Optical networks; Control plane; ASON; Photonic switching; All-optical networks

---

## 1. Introduction

The term *optical networks* is often used to denote networks employing any sort of optical technology to convey signals over distances. In their early form, predominantly used today, they are sets of optical fibers interconnecting electronic switches [1]. Such networks are often referred to as first-generation optical networks. In the second-generation optical networks, some routing and switching is performed in the optical domain, without signal conversion to the electrical form [2].

The spectacular success of optics in communications networks has triggered even higher expectations. Many experts predict evolution towards what they call “all-optical networks”. For some this term is used in its literal meaning. In such a case not only are client signals transported between end user pieces of equipment exclusively in the optical domain, but also all processing, including control of optical switches, uses some sort of optical technology. In this extreme solution, electrical signals are simply nonexistent. For some more moderate advocates of all-optical networks, the use of electronics is strictly limited to control circuitry associated with optical switching or transport devices. However, the usual way of thinking is formulated as follows: “optics is generally better than electronics, and, therefore, it should gradually

---

\* Tel.: +48 12 634 5582; fax: +48 12 634 2372.  
E-mail address: [jajszczyk@kt.agh.edu.pl](mailto:jajszczyk@kt.agh.edu.pl).

### List of Acronyms

2D	Two-Dimensional
3D	Three-Dimensional
3R	Reamplification, Reshaping, Retiming
ASON	Automatically Switched Optical Network
ATM	Asynchronous Transfer Mode
EDFA	Erbium Doped Fiber Amplifier
E/O	Electro-Optical
FEC	Forward Error Control
GbE	Gigabit Ethernet
GFP	Generic Framing Procedure
GMPLS	Generalized MPLS
IP	Internet Protocol
ITU-T	International Telecommunication Union —Telecommunications Standardization Sector
LAN	Local Area Network
LCAS	Link Capacity Adjustment Scheme
MAC	Medium Access Control
MEMS	MicroElectroMechanical System
MPLS	Multi-Protocol Label Switching
NNI	Network–Network Interface
OADM	Optical Add–Drop Multiplexer
OC	Optical Carrier
O/E	Opto-Electrical
OEO	Optical–Electrical–Optical
OTN	Optical Transport Networks
OXC	Optical Cross-Connect
PPP	Point-to-Point Protocol
QoS	Quality of Service
RPR	Resilient Packet Ring
SAN	Storage Area Network
SDH	Synchronous Digital Hierarchy
SLA	Service Level Agreement
SOA	Semiconductor Optical Amplifier
SONET	Synchronous Optical Network
STM- <i>N</i>	Synchronous Transport Module level <i>N</i>
STS	Synchronous Transport Signal
TDM	Time Division Multiplexing
UNI	User–Network Interface
VC	Virtual Concatenation
VCG	Virtual Concatenation Group
VLSI	Very Large Scale Integration
WAN	Wide Area Network
WDM	Wavelength Division Multiplexing

become the dominant, if not the only, technology; the only problem is that until some optical technologies are sufficiently mature we have to (temporarily) use electronics”.

In this paper, I will try to present and discuss a balanced view on the place of optics and electronics in current and future communications networks, showing both advantages and limitations of the two technologies. Table 1 contains lists of such advantages in the context of telecommunications.

Very high bandwidth of optical fibers makes it possible to achieve transmission speeds exceeding Tb/s in a single-wavelength multiplexed optical fiber [3]. Even a single wavelength can accommodate signals reaching, in currently manufactured transmission systems, bit rates of 40 Gb/s. This bit rate is, in fact, limited by the speed of electronic transmitters feeding the fiber, rather than the fiber itself. Optical fibers are also characterized by a very low transmission loss per unit length. This facilitates building transmission systems with very long spans (e.g., exceeding 100 km) without signal regeneration. The immunity to electromagnetic interference means that cables containing hundreds of fibers can be built with ease, and each fiber can carry more than a hundred parallel wavelengths. The advantages of inherent parallelism of optical devices are also visible in free-space optics. Another important feature resulting from the immunity to electromagnetic interference is signal security. Tapping optical signals is much more difficult than tapping their electrical counterparts.

The fact that photons, in contrast to electrons, do not interfere with each other makes building purely optical logic devices difficult. Such logic devices, often of a very complex functionality, are manufactured by using electronic technology. Advances in VLSI design allow building very fast and versatile processing units. Attempts to build “optical computers”, although widely publicized, have failed to meet expectations, and their capabilities are far behind those of electronic processors.

Although the electrical domain does not offer such a high bandwidth as optics, it facilitates transmission of signals of higher granularity. This means that instead of a limited number of high bandwidth optical “pipes” we can accommodate lots of signals of different bit rates generated directly by end users. These low rate electrical signals can be easily multiplexed and

Table 1  
Advantages of optical and electronic technologies in communications networks

Optics	Electronics
High bandwidth	Ease of building complex logical devices
Large optical “pipes”	High granularity of transmitted signals
Long transmission spans without regeneration	Ease of signal regeneration
Immunity to electromagnetic interference	Ease of signal quality monitoring
Large installed base of fibers in core network	Large installed base of copper in access networks

then transmitted together through a high rate optical channel.

Digital signals in the electrical domain have to be frequently regenerated (e.g., every 2 km). However, such an electronic regeneration is relatively simple in contrast to regeneration in the optical domain. Monitoring of the quality of electrical signals, including bit error rate measurements, is also easy.

## 2. Electro-optical networks

### 2.1. Transport, control, and management planes of optical networks

Although the success of optical networking technology gave rise to great expectations for all-optical networks, the reality is the coexistence of optics and electronics in currently used networks. This coexistence is illustrated in Fig. 1. In contemporary communications networks we can distinguish the following three functional planes [4]:

- transport plane,
- control plane,
- management plane.

The *transport plane*, referred to also as the data plane, represents the functional resources of the network which convey user information between locations. This plane can also provide transfer of some control and network management information. A layer network within the transport plane is a topological component that includes both transport entities and transport processing functions that describe the generation, transport, and termination of signals with

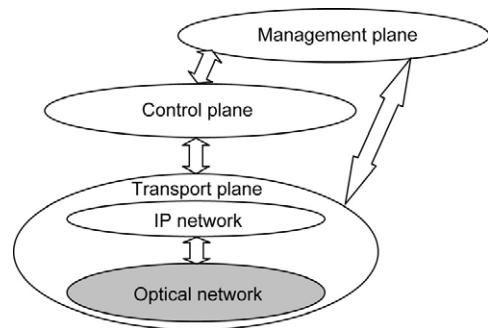

Fig. 1. An electro-optical network.

a specific format (called *characteristic information*) which are transferred on network connections. IP, ATM, SDH/SONET, and OTN (Optical Transport Network) are examples of layer networks. In Fig. 1, only two layer networks, namely IP and the optical network, are shown.

The *control plane* performs the call control and connection control functions. The functions of the control plane can be automated, on the basis of networking intelligence that includes automatic discovery, routing, and signaling [5]. The *management plane* performs management functions for the transport plane, the control plane, and the system as a whole, as well as coordinating operation of all the planes. These management functions are related to network elements, networks, and services and, usually, they are less automated than those of the control plane.

It can be easily seen that, in existing networks, the functionality of both the control and management planes is realized in the electronic domain. Some exceptions are possible, including the optical signaling network used to convey information within the control

plane. Also, the equipment of the currently used IP networks uses electronics to route, forward, and store IP packets.

## 2.2. Interconnection models

The control planes serving the IP and optical networks of Fig. 1 can be loosely or tightly coupled. Such a coupling determines an interconnection model representing exchange of the topology and routing information related to both networks, the level of control that IP routers exercise in selecting paths in the optical network, as well as access control, accounting, and security issues [6]. We can distinguish the following three interconnection models:

- the overlay model,
- the peer model, and
- the augmented model.

In the overlay model, the IP layer and the optical network control planes are independent. They do not exchange any routing or topology information. The client IP layer can request optical paths from the optical layer via a user–network interface (UNI). The overlay model suits well the common situation where the optical backbone infrastructure and client electro-optical networks belong to different operators. Disadvantages of this solution include the duplication of routing protocols, a need for independent addressing schemes, and poor scalability [7,8].

In the peer model a single control plane controls both the IP and the optical network. A common addressing scheme is implemented. The peer model allows the development of a unified traffic engineering scheme that might optimize the utilization of resources in both optical and IP networks [9]. The peer model, however, may not be attractive to optical transport network carriers who usually are not ready to share detailed network topology information with their clients.

The third interconnection model, referred to as the augmented model, is a compromise between the overlay and the peer model. It resembles the overlay approach in using separate routing instances in the IP and optical domains but reachability information is exchanged through interfaces between the two layers.

Another compromise between the overlay and the peer models might be using a combination of the two, where the overlay approach is used to support multiple administrative domains and the peer model is applied to support heterogeneous technologies within a single domain.

## 2.3. Layering in optical networks

Fig. 2 shows that even the “optical network” of Fig. 1 is not fully optical. In fact, within its several layer networks, only the lowest, physical layer extensively uses optical technology. But this lowest layer is not fully optical, either. At some points opto-electronic conversions are necessary, either for signal regeneration, signal monitoring, or grooming. 3R (*Reamplification, Reshaping, Retiming*) regeneration is needed to remove the effects of a number of optical transmission impairments accumulating along the optical path. Although all-optical 3R regeneration is, in principle, possible, it remains at a research stage. A signal in its electric form is also needed to verify Service Level Agreements (SLAs), especially at the borders between different carriers as well as for traffic grooming and multiplexing. SLA verification could also be done by converting only a small fraction of the optical energy at drop ports, without converting the whole signal in the optical path [10].

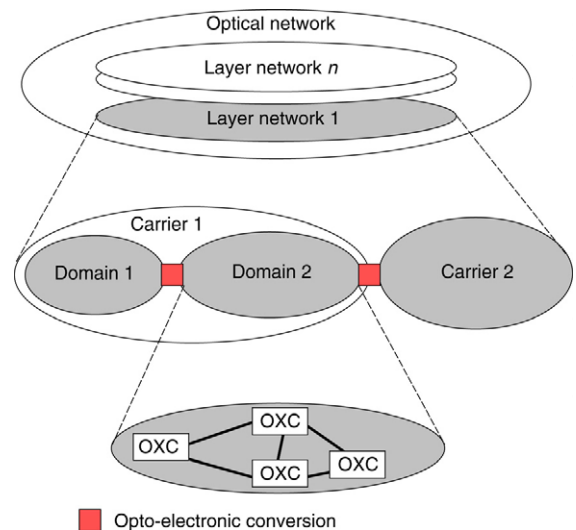

Fig. 2. An optical network.

According to the “level” of opto-electronic conversions, optical networks are usually termed transparent, opaque, and translucent networks. In transparent networks optical signals are transported from a source to a destination entirely in the optical domain without OEO (optical–electrical–optical) conversion. In such a case we can distinguish a *lightpath* representing a temporary end-to-end optical communication connection between the source and the destination. The lightpath may use a single wavelength over its route, but in some networks wavelength conversions at some or all nodes are allowed (but when OEO conversion is used, such a network is no longer transparent). The latter approach allows for wavelength reuse that may lead to a more efficient resource utilization. In opaque networks all transit nodes may employ OEO conversion. The third kind of optical network is a sort of intermediate solution, and involves opto-electronic conversions at only some transit nodes, while the remaining nodes are fully transparent. For example, in translucent networks, an optical signal travels as long as possible before its quality falls below a predetermined threshold. The other reason for using opaque transit nodes at some points is the need for traffic grooming or multiplexing.

The advantage of transparency is the possibility for an operator to provide a variety of different services using a single infrastructure [2]. For example, on different wavelengths, analog signals can be carried together with digital signals of varying bit rates and formats [6]. Another advantage of transparent networks is the fact that they are future-proof. This means that they are able to support new protocols and new bit rates without any need to replace equipment inside the network [2].

One of the most challenging problems in optical networks is efficient utilization of bandwidth provided by a single wavelength. Usually, such a bandwidth is much higher than a typical connection request. If an entire optical channel is allocated to a single, low speed connection, a considerable part of the lightpath is wasted. Additionally, for a typical network, the number of source–destination traffic connections is much higher than the number of available wavelengths. These observations have led to the concept of traffic grooming where low speed traffic is groomed to share the resources in the optical layer [11, 12]. Although most studies concentrate on packaging

low speed connections onto lightpaths by using time division multiplexing, the grooming solution can use other multiplexing methods, such as frequency division and statistical (packet-oriented) multiplexing. Fixed-time division or statistical multiplexing-based traffic grooming is a good example of the coexistence of optical and electronic technologies in current and future networks.

### 3. Optical cross-connects

#### 3.1. Cross-connect architecture

Although early optical networks based on SDH/SONET technology extensively used ring-based architectures for protection and restoration, current needs related to the increasing Internet Protocol (IP) traffic lead to mesh-type topologies [13]. *Meshed networks* represent an architecture where any number of nodes are arbitrarily connected together with at least one loop. The nodes of such meshed networks employ *Optical Cross-Connects* (OXCs) and *Optical Add/Drop Multiplexers* (OADMs). An OXC switches an optical data stream from any input port to any output port. Such a switch is usually controlled by the management plane while setting up or terminating lightpaths [14].

An important characteristic of an optical cross-connect is its wavelength switching capability. In its simplest form, the cross-connect, referred here to as a fiber switch, is able to switch between different fibers but without any changes of wavelength allocation in any fiber. In the second solution, the switch is able to move separate wavelengths between fibers. The most advanced solution, along with space switching, enables wavelength conversions. Such wavelength interchanging cross-connects, although still very costly, can be used in flexible wavelength routed networks.

Cross-connects operated by the management plane are relatively slow and the established connections may not change for long periods (hours or days) [3]. However, cross-connects controlled by the control plane, i.e., by using call traffic signaling, can be reconfigured more frequently and their required switching times might be considerably shorter for reaching the overall protection switching target of 50 ms [15].

An OADM is able to drop one or more low speed streams from a high speed stream, as well as to add such low speed streams to a high speed stream [2,3]. In DWDM networks such operation may involve selective removal or addition of a wavelength from or to a fiber.

We can distinguish several kinds of cross-connects termed optical. Their common feature is the fact that they have at least some optical interfaces accommodating optical transmission systems. They can have either electrical or optical switching fabrics. Even in the second case, in practical solutions, OEO conversions are necessary between optical interfaces and in the optical switching fabric for regeneration, signal monitoring, control, and management as well as traffic grooming. Although such conversions are costly, the fully transparent cross-connects without any OEO conversions seem set to play a rather marginal role in forthcoming years.

Even if we resolve all problems related to 3R regeneration in the optical domain, electronic circuitry will be present in optical cross-connects, as illustrated in Fig. 3. In this case we still need conversions into the electrical domain for grooming purposes. Even the optical part of the cross-connect uses an optical switching fabric which is electronically controlled. Although investigations on fully optical control have been carried for more than 20 years, the results are still very far from practical implementations. I, personally, believe that electronic processing for control purposes has no competitor in the optical domain for the foreseeable future. A reasonable long term approach would be to develop optical cross-connects with fully optical transmission path, provided that no grooming is needed, but to keep electronic control.

### 3.2. *Optical switch fabrics*

As regards optical switching fabrics, several technologies are available. They are based on either guided-wave or free-space optics. Early guided-wave switches, first demonstrated in 1975, used directional couplers or Mach–Zehnder interferometers integrated on dielectric or semiconductor substrates, and were based on the electro-optic effect. Although elementary switches had only two inputs and two outputs, larger capacity matrices could be built by using various arrangements of those  $2 \times 2$  switches [16]. A variety

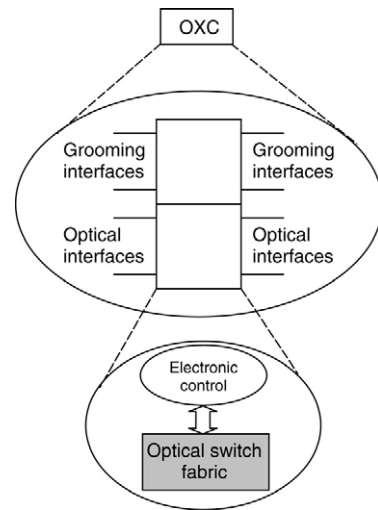

Fig. 3. A conceptual view on an optical cross-connect.

of other technologies have also been investigated, including Semiconductor Optical Amplifiers (SOA) and thermo-optic or WDM-based switches. The free-space switching solutions were based on either electro-optic phenomena, such as liquid crystals, or beam deflection using mirrors, prisms, or holographic devices. Recently, photonic crystals have attracted lots of attention from the research community.

Although optical or, more generally, photonic switching has been investigated for 30 years, most of the proposed solutions suffered from poor performance parameters, such as: low reliability, low thermal and time stability, high loss and cross-talk, high energy consumption (cooling problems), as well as very high cost. In recent years, however, at least two practically viable optical switching technologies have been developed. Their success is partly due to the fact that both are aimed at producing optical cross-connects requiring rather relaxed switching times (say, on the order of milliseconds) in contrast to real time switches that can be used, for example, in optical packet switches and requiring nanosecond switching times. The practically viable technologies, mentioned above, include MEMS (MicroElectroMechanical System) switches and “bubble” optical switches. Semiconductor Optical Amplifiers (SOA) are also considered by many a viable switching technology.

The first kind of switch belongs to the free-space group and uses a set or two sets of electrostatically

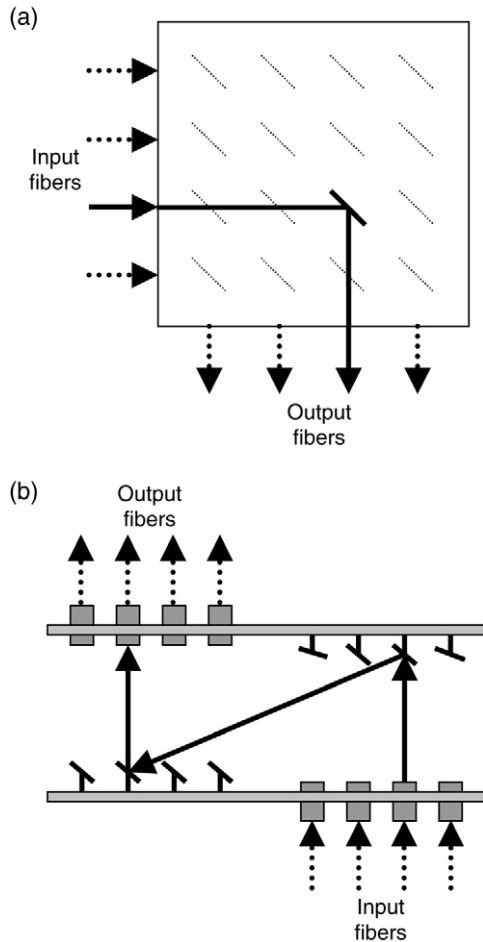

Fig. 4. MEMS-based optical switches; (a) 2D MEMS, (b) 3D MEMS.

controlled movable mirrors to reflect light [2,17,18]. An array of such miniature mirrors, of diameters as small as a few hundred micrometers, and deflected from one position to another by using, for example, electrostatic methods, is able to switch a multiplicity of light beams carrying optical channels of practically any rate. We can distinguish two basic types of MEMS-based switch, namely the 2D (two-dimensional) MEMS, shown in Fig. 4(a), and the 3D MEMS, shown in Fig. 4(b).

An  $N \times N$  switch of the first type requires  $N^2$  mirrors, while the 3D MEMS switch needs only  $2N$  mirrors. The mirrors in the latter switch, however, have to be controlled in an analog fashion to realize any required deflection angle. The 2D MEMS switch

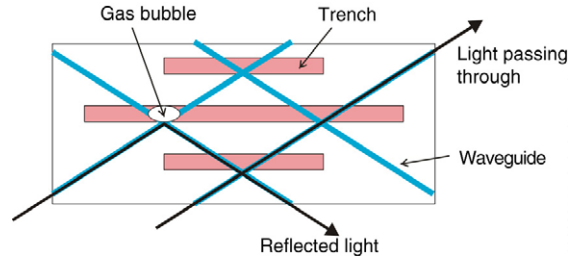

Fig. 5. The bubble-based switch.

contains a simpler control mechanism that sets mirrors in one of the two possible states (“up” and “down”).

The bubble optical switches are thermally activated devices using intersecting waveguides. The operation principle is shown in Fig. 5 [19]. The crossing waveguides are fabricated on a planar substrate. The crossovers align with trenches filled with substrate index matching fluid. In the “pass” state, light propagates in the waveguide without changing its direction. Evaporation of the fluid at the waveguide crossing point, by heating this point, results in light reflecting from the bubble and being directed to the other waveguide.

Fig. 6 classifies optical switches on the basis of the most promising fabrication technologies, dividing them into two broader groups: guided-wave based and free-space based. Table 2 contains relative advantages and disadvantages of the switches shown in Fig. 6 [2,20,21].

#### 4. Trends in optical networking technologies

The steady growth of traffic, along with the developments in photonic technology, influences the architecture of optical networks as well as increases the penetration of optics in signal transport systems. Some of the relevant technologies will be briefly reviewed here. We will begin with the optical layer, covering developments of WDM networks and overviewing the *Optical Transport Network (OTN)* standard that, although it involves also the electrical domain, was developed to efficiently operate terabit-per-second multi-wavelength optical pipes. Then, networking solutions based on optical packet and burst switching will be presented. These technologies attempt to match the packet-oriented IP traffic better with the optical transport infrastructure. The overview

Table 2  
Comparison of optical switching technologies [21]

Technology	Advantages	Disadvantages	Applications
Moving fiber	Low loss and cross-talk	Long switching time, poor scalability	Protection and restoration, OADMs
MEMS	Small size	Limited reliability (mechanical elements)	OXCs
Bubble	Easy to integrate	Long switching times, high energy consumption	Protection and restoration, OADMs
Thermo-optic (Mach–Zehnder)	Easy to integrate	Long switching times, high loss and cross-talk, poor scalability, high power consumption	Protection and restoration, OADMs, OXCs
Liquid crystal	Parallelism of switched signals	Characteristics highly temperature dependent	Protection and restoration, OADMs, OXCs
Lithium niobate based	Fast switching	High loss and cross-talk, possible changes of light polarization, poor scalability	Protection and restoration, OADMs, packet switching
Semiconductor optical amplifiers (SOA)	Fast switching, loss compensation	Poor scalability, high noise	Protection and restoration, OADMs, packet switching

of the current developments will be concluded by discussing the evolution of electronic-type network technologies that play an essential role in “pumping” bits to the optical layer.

#### 4.1. WDM networks

In *Wavelength Division Multiplexed* (WDM) networks each fiber carries a multiplicity of wavelength channels. Steady progress in optical device technology resulted in the commercial availability of WDM systems supporting as many as 160 wavelength channels, each carrying a 10 Gb/s stream. We can expect transmission speeds per wavelength as high as 40 Gb/s. This progress is possible because of the new developments in fiber Bragg gratings with 25 GHz channel separation [22]. Another important development concerns the Erbium Doped Fiber Amplifier (EDFA) technology. The implementation of such optical amplifiers allows creation of long optical lightpaths without a need for regeneration in the electrical domain. Efforts are under way to develop fully optical 3R regeneration as well, but practical implementation of the relevant technologies seems still to lie in the distant future [23].

One of the fundamental problems in WDM transport networks is routing and wavelength assignment, extensively covered in the literature [2,24]. Wave-

length converting capability at optical cross-connects allows flexible utilization of resources (wavelengths), but it currently requires using opto-electronic converters. It should be noted, however, that all-optical wavelength conversion is being studied [25]. If it is implemented in commercial products, it will lead to a significant advancement in all-optical networks. Developments in all-optical 3R regeneration would also extend the reach of transparent optical networks [23]. Another important milestone in this area is the introduction of optical monitoring for WDM systems [26].

#### 4.2. The optical transport network

The Optical Transport Network (OTN) standard has its roots in the digital wrapper of an optical channel technology [27]. Such a digital wrapper defines an overhead in the optical layer used to monitor the bit error ratio as well as to implement an efficient coding improving the observed signal quality. Along with addressing the need to decrease the error rate in optical links, it was designed to provide functionality of transport, multiplexing, routing, management, supervision, and survivability of optical channels carrying any digital client signals [28]. A distinguishing feature of the OTN is its provision



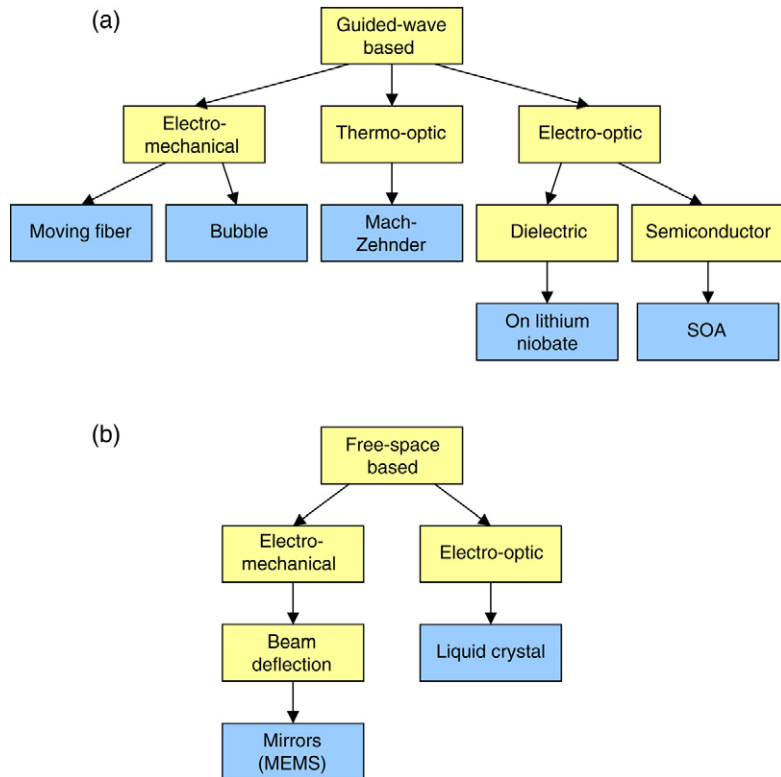

Fig. 6. Optical switch technologies; (a) guided-wave-based switches, (b) free-space-based switches.

of transport for any digital signal independently of client-specific aspects, i.e., it provides client independence. It was assumed that introduction of the OTN networks at the optical layer would enable telecommunications operators to provide digital services of controlled quality to the most important customers, customers requesting high data rates and high quality services. OTN supporting protection at the optical layer is the step in the network evolution path supporting the demand for high quality services, while implementation of restoration protocols at the same time will additionally assure better resource usage and promises cost reduction for offered services.

The implementation of the OTN ensures that digital optical services may be offered, in contrast to the purely analog WDM technology. Another distinction between WDM and OTN is that the latter allows network operators to guarantee QoS parameters at the optical layer due to the implementation of forward error control. Moreover, OTN connection

monitoring capabilities allow operation in a multi-carrier environment. Such connection monitoring can be conducted on both end-to-end and per carrier bases at the same time.

The major distinction between OTN and SDH/SONET (described in Section 4.4) is the fact that the former operates at the Tb/s or Gb/s level without getting involved in Mb/s transmissions as in the case of SDH/SONET [1]. OTN may efficiently operate on many wavelength channels, providing, for example, survivability functions at the optical level. Another important feature of the OTN, not present in the SDH/SONET standard, is the existence of *Forward Error Control* (FEC) that allows building very long optical links without regeneration [15].

The expectations behind the development of the OTN included replacement of, at that time, outdated and inflexible SDH/SONET technology. However, later enhancements of SDH/SONET, its large installed base, and current limits on expenditure resulted in

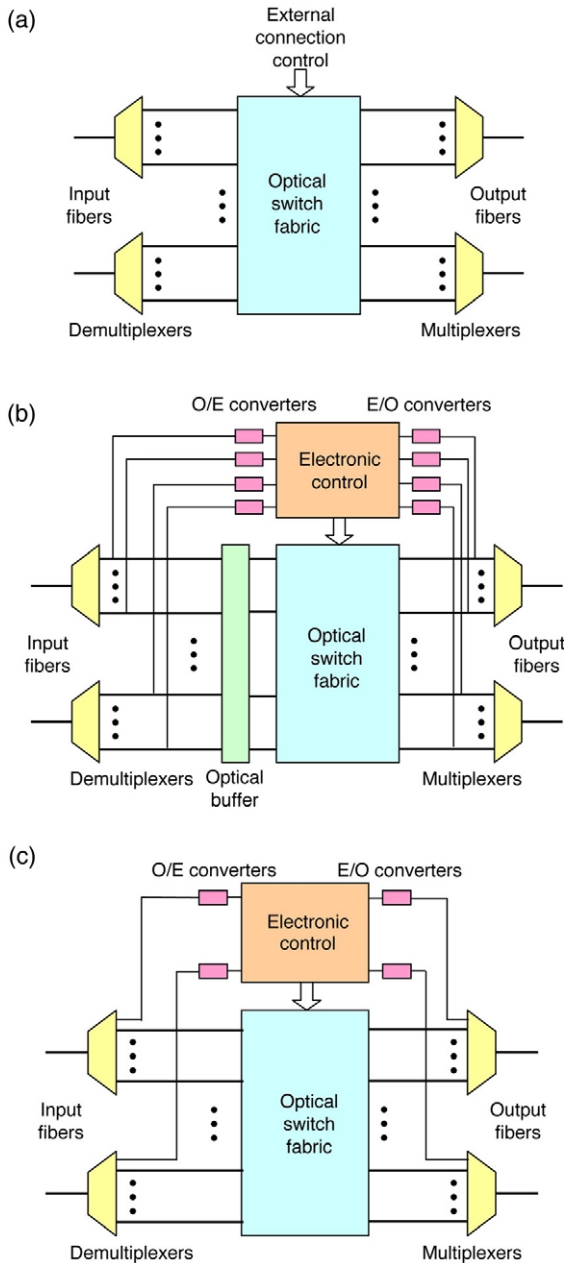

Fig. 7. Optical switching nodes; (a) circuit switching, (b) packet switching, (c) burst switching [29].

practical shelving of the OTN. However, the OTN technology has a chance of reviving when, in some years' time, carriers decide to replace their aging SDH/SONET equipment.

### 4.3. Optical packet and burst switching

The wavelength routed networks mentioned in Section 4.1 employ the principle of circuit switching, i.e., a lightpath is reserved for data transmission for the whole duration of a connection, independently of whether the data is actually sent or not in a given instant of time. Connections in switching nodes (cross-connects) are set up by external control signals coming from either the management or control plane (Fig. 7(a)). Such an approach does not match the packet-oriented traffic mostly carried in optical core networks.

Direct replacement of elements of an electronic packet switch by devices operating in the optical domain is difficult or even impossible. One of the reasons is the fact that the switching time has to be considerably smaller than a packet duration. In the optical domain, this translates into a switching time on the order of a few nanoseconds [2]. The other constraint is related to the lack of cost-efficient optical random access memories that are required in all conventional packet switches. Other difficulties include synchronization of optical signals and optical processing of packet headers.

A simplified architecture of an optical packet switch with electronic header processing is shown in Fig. 7(b) [29]. The wavelengths on incoming fibers are demultiplexed and the headers are stripped of the packets, converted to the electrical form, and then processed by electronic circuitry. The optical payloads, after buffering to compensate processing time, are directed to selected output ports in the optical switch fabric and then supplemented with new headers. Optical buffers are usually realized by using fiber delay lines [2,30]. Although the optical buffers in the packet switch of Fig. 7(b) are located at switch fabric inputs, other arrangements, such as output or recirculation buffering, are also possible [2].

In the burst switching (Fig. 7(c)), a source transmits a header followed by a packet burst. Such a burst is usually several orders of magnitude longer than a typical packet. The header, in the form of a separate control packet, is transmitted at a lower speed on a dedicated control channel [2,29]. This control packet is processed electronically at each node and activates the switch fabric to connect the associated burst to the appropriate output port. Since the burst is switched in

an optical form in a so-called “cut-through” manner, no buffering is needed.

Although the possibility of optical header processing has been demonstrated [31], such a solution is currently not economically viable. A variety of experimental arrangements of packet and burst switching nodes have been described in the literature, for example in [2,29,32,33].

#### 4.4. Electronic layers on top of an optical network

As mentioned earlier, any transport network, although often termed an optical network, is in fact a multi-layer system using both optical and electronic technologies. A conceptual view of various technologies developed to support optical networking is shown in Fig. 8. It should be noted, however, that this view represents some longer term expectations concerning the networking technologies. These technologies will be briefly reviewed and their implementation prospects discussed.

##### 4.4.1. SDH/SONET

The *Synchronous Digital Hierarchy* (SDH) or *Synchronous Optical Network* (SONET) is a widely used, well-understood, mature, and standardized technology. This layer network is located just above the optical layer. Although SDH/SONET uses standardized optical interfaces, its digital framing structure requires electronic processing, monitoring, and management. Since SDH/SONET was initially designed for optimizing the transport of 64 kb/s-based TDM services, a rigid capacity of payload as well as a coarse fixed-rate multiplexing hierarchy was originally defined. Today, SDH/SONET systems are built with bit rates reaching 40 Gb/s (STM-256/OC-768). To better serve data traffic that currently dominates in transport networks, several enhancements to SDH/SONET have been proposed and standardized. They include the Virtual Concatenation (VC) technique, the Link Capacity Adjustment Scheme (LCAS), and the Generic Framing Procedure (GFP) [15].

*Virtual concatenation* provides effective use of SDH/SONET capacity by allowing a flexible concatenation of several SDH/SONET payloads. Virtually concatenated payloads constitute a Virtual Concatenation Group (VCG). Members of a VCG, as opposed to the contiguous concatenation situation, may not reside

in the same STM- $N$ /OC- $N$  contiguously, or may even reside at different STM- $N$ /OC- $N$  interfaces. As a consequence, they may reach the destination through various routes. Intermediate nodes do not need to handle virtual concatenation and the VC functionality must be implemented only at path termination nodes. This feature makes it possible to deploy virtual concatenation on legacy SDH/SONET equipment of existing networks. On the other hand, it should be noted that differences in delay of an individual concatenated signal may occur due to pointer processing at intermediate nodes. Compensation of differential delays is handled at the destination node. Another advantage of virtual concatenation is its ability to divide STM- $N$ /OC- $N$  bandwidth into several subrates. Each subrate may be used for accommodation of a different service.

Another improvement to SDH/SONET technology is the *Link Capacity Adjustment Scheme* (LCAS) protocol. LCAS is an extension to virtual concatenation. It allows a dynamic alteration of bandwidth of SDH/SONET/OTN transport pipes. This is an important bandwidth saving functionality for the transport of data traffic coming from IP applications. The number of concatenated payloads may be increased or decreased at any time without affecting traffic currently being sent. Moreover, LCAS will automatically decrease the capacity if a member of VCG experiences a failure in the network, and LCAS will increase the capacity when the network recovers. When one of the constituent channels experiences a failure, the failed channel will be automatically removed while the remaining channels are still working. Thus, the available bandwidth will be lowered but the connection will be maintained.

At this stage, it seems that the center of gravity will shift towards services offered through enhanced SDH/SONET over WDM rather than services over the Optical Transport Network (OTN).

##### 4.4.2. The generic framing procedure

The *Generic Framing Procedure* (GFP) evolved from the Simple Data Link (SDL) protocol as a more generic framing mechanism. Similarly to SDL, and earlier ATM (Asynchronous Transfer Mode), GFP uses correlation between selected fields of the header and the respective header error CRCs (Cyclic Redundancy Checks) to delineate the served data unit. The Generic Framing Procedure, although initially

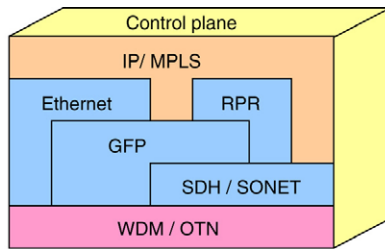

GFP: Generic Framing Procedure  
 IP / MPLS: Internet Protocol / Multiprotocol Label Switching  
 OTN: Optical Transport Network  
 RPR: Resilient Packet Ring  
 SDH / SONET: Synchronous Data Hierarchy / Synchronous Optical Network  
 WDM: Wavelength Division Multiplexing

Fig. 8. Networking technologies in transport networks.

developed to facilitate mapping of a large variety of data signals on SDH/SONET frames, has a wider scope and can also be used outside SDH/SONET systems. The ITU-T recommendation defines two transport modes [34]. The first mode, referred to as Frame-Mapped GFP (GFP-F), is optimized for the adaptation of PDU-oriented streams such as IP, native PPP, MPLS, and Ethernet traffic. The second mode, optimized for block-code-oriented streams, is called Transparent GFP (GFP-T). This mode is used for Gigabit Ethernet, Fiber Channel, FICON (Fiber Connection), and ESCON (Enterprise Systems Connection) traffic. The two transport modes may coexist within the same transport channel. GFP addresses requirements of delay-sensitive applications such as Storage Area Networks (SAN). It is also expected to support the new RPR standard. Another advantage of GFP is its particular suitability for high speed transmission links stemming from reduction of processing requirements for data link mappers/demappers as well as simplification of receiver logic [35].

#### 4.4.3. The resilient packet ring

*Resilient Packet Ring (RPR)*, standardized as IEEE 802.17, is a new technology for ring-based metropolitan area networks aimed at efficient transport of packet-based data traffic and featuring bandwidth efficient fast protection mechanisms [36,37]. RPR arises from pre-standard products of different vendors, including Cisco's Dynamic Packet Transport (DPT) and Nortel's Optera. It effectively transforms a chain of point-to-point SDH/SONET links between nodes to a single virtual shared medium. RPR includes a new

MAC (Medium Access Control) layer technology that employs a spatial reuse to maximize the bandwidth utilization, provides a distributed fairness algorithm, a differentiated Quality of Service (QoS) scheme and network survivability similar to SDH/SONET-APS. RPR allows also the full ring bandwidth to be utilized under normal conditions and protects traffic in the case of a nodal failure or a fiber cut using a priority scheme. Other advantages of RPR include support for unicast, multicast, and broadcast data traffic, plug-and-play operation, scalability in speed and number of nodes, as well as inter-operability with major transmission standards.

#### 4.4.4. Ethernet

*Ethernet* is the dominant enterprise technology in the local area, serving about 98% of all data traffic [38]. Ethernet services are provided over a standard, widely available, and well-understood interface. Therefore, it is no surprise that a variety of Ethernet service delivery technologies have been developed, including those over optical networks. In recent years, Gigabit Ethernet widely found its way into the metropolitan, regional, and even wide area networks. 10 gigabit Ethernet continues the evolution towards higher bit rates and an extended range. Two types of physical interface have been defined: the first one is suitable for local and metropolitan area network operation (LAN PHY: 10GBase-X, 10GBase-R), the second one for wide area networks (WAN PHY: 10GBase-W) [39]. The 10 gigabit Ethernet standard proposes physical interfaces based both on single-mode and multi-mode fibers. By the use of single-mode fibers, 10 GbE LAN PHY offers higher data rates and extended reach compared to 1 GbE. 10 GbE can operate over a 40 km long single-mode fiber link. WAN PHY differs from the LAN PHY implementation by the use of the SDH/SONET framing with reduced functionality. The output from the WAN PHY is compatible with the synchronous frame format (VC-4-64c or STS-192c) and can be easily transported over an Optical Transport Network (OTN). Unlike SDH/SONET, the Ethernet technology does not provide a fast protection mechanism.

The Metro Ethernet Forum has also developed two standards for Ethernet connectivity services, i.e., the Ethernet Line Service (E-Line) and the Ethernet LAN

Service (E-LAN) [40]. The former provides a point-to-point virtual connection, while the latter provides multi-point connectivity.

## 5. The control plane for optical transport networks

Optical transport networks, based on SDH/SONET and WDM technologies, and designed mainly for voice applications, do not match current needs triggered by rapid growth of data traffic. Available resources often cannot be properly allocated due to inherent inflexibility of manually provisioned large scale optical networks. This problem may be solved by using an electronic control plane that performs the call and connection control functions in real time. One of the most promising solutions is based on the concept of automatically switched optical networks. *Automatically Switched Optical Network* (ASON) is an optical transport network that has dynamic connection capability. This capability is accomplished by using a control plane that performs the call and connection control functions [41].

Provisioning of optical channels in minutes or even seconds would open new opportunities related to better resource utilization, creation of new services, such as bandwidth on demand, and a range of traffic engineering mechanisms. Optical network resources can be automatically linked to data traffic patterns in client networks. Creation of a separate control plane will significantly impact the network operation and management. Connections can be set up in a multi-vendor and a multi-carrier environment without relying on inter-operability between different management systems. Such systems will also be relieved from route selection and the need to manually update the network topology. This, in turn, will increase scalability which is essential to support switched connections on a global scale.

New protection and restoration schemes for mesh-type optical transport networks will improve the reliability performance measures offered to customers. Such measures are especially important if we take into account very high bit data rates switched in optical networks. The control plane rapidly reacting to failures in the optical network will make it possible to reallocate traffic to reserve paths in real time.

Large scale transport networks are difficult to plan and design. Lack of reliable traffic data,

uncertainty of future service needs predictions, and the large variety of available protocols and interfaces make the network design process a real challenge. The standardized control plane will enable the reuse of existing protocols and will reduce the need to develop operational support systems for configuration management. Moreover, the possibility of dynamically allocating optical network resources to changing traffic patterns will facilitate network planning, in contrast to statically configured networks.

The ASON standardization defines in the control plane the following three logical interfaces and relevant reference points (see Fig. 9) [4,41]:

- The *User–Network Interface* (UNI): a bi-directional signaling interface between service requester and service provider control plane entities.
- The *Internal Network–Network Interface* (I-NNI): a bi-directional signaling interface between control plane entities belonging to one or more domains having a trusted relationship.
- The *External Network–Network Interface* (E-NNI): a bi-directional signaling interface between control plane entities belonging to different domains.

The principal functions of the control plane include discovery functions, routing, signaling, as well as protection and restoration schemes.

*Automatic discovery* eliminates the need for explicit configuration activity. *Neighbor discovery* is responsible for determining the state of local links connecting to all neighbors. This kind of discovery is used to detect and maintain node adjacencies. *Resource discovery* has a wider scope than neighbor discovery. It allows every node to discover network topology and resources. Some details of the complete topology can be hidden in the nodes located in other network domains. This kind of discovery determines what resources are available, what the capabilities of various network elements are, how the resources are protected. It improves inventory management as well as detecting configuration mismatches. *Service discovery* is responsible for verifying and exchanging service capabilities of the network, for example, services supported over a trail or link. Such capabilities may include the class of service (CoS) or the grade of service (GoS) supported by different administrative domains, the ability to support flexible

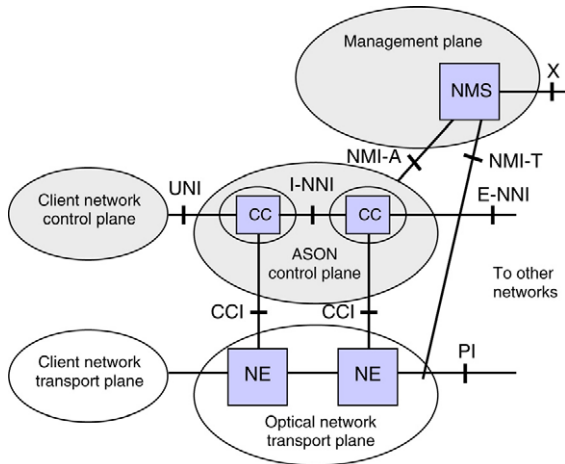

CC: Connection Controller  
 CCI: Connection Control Interface  
 E-NNI: External Network-Network Interface  
 I-NNI: Internal Network-Network Interface  
 NE: Network Element  
 NMI-A: Network Management Interface – ASON control plane  
 NMI-T: Network Management Interface – Transport plane  
 NMS: Network Management System  
 PI: Physical Interface  
 UNI: User-Network Interface  
 X: Interface between management systems

Fig. 9. A logical view of ASON architecture [41].

adaptation at either end of the connection, and the ability to support diverse routing.

*Routing* is used to select paths for establishment of connections through the network. Although some of the well-known routing protocols developed for the IP networks can be adopted, it has to be noted that optical technology is essentially an analog rather than digital technology and, therefore, transmission impairments accumulated along the optical paths have to be taken into account while calculating the route. Another constraint influencing routing mechanisms, related to ASON, but also to any operator being an ISP (Internet Service Provider) or a bandwidth service provider, is the fact that carriers do not allow other carriers or private domain visibility of their internal network topologies. Because of the large scale of the networks considered the routing protocols should minimize global information as much as possible.

*Signaling* involves transporting control messages between all entities communicating through a network's control plane. Signaling protocols are used

to create, maintain, restore, and release connections. Such protocols are essential for enabling fast provisioning or fast recovery after failures. It is important that a variety of different signaling protocols can inter-operate within a multi-domain network and the inter-domain signaling protocols must be agnostic to their intra-domain counterparts. Several recommendations concerning signaling issues in ASON were developed by ITU-T, including signaling mechanisms and protocol specifications based on PNNI (Private Network to Network Interface) [42], GMPLS RSVP-TE (Generalized Multi-Protocol Label Switching Resource Reservation Protocol) [43], and GMPLS CR-LDP (GMPLS Constraint Routing Label Distribution Protocol) [44].

The higher network reliability in ASON is achieved by using various survivability schemes supported by either protection or restoration mechanisms. Survivability in ASON involves all three functional planes. In the case of transport plane protection, the configuration of the protection is the responsibility of the management plane. However, the transport plane should inform the control plane about all failures of transport resources as well as their additions or removals. Unsuccessful transport plane protection actions may trigger restoration supported by the control plane. In the case of control plane protection, the control plane creates both a working connection and a protection connection. Control plane restoration is based on rerouting of calls using spare capacity. An important principle is that the existing connections in the transport plane should not be affected by failures in the control plane. However, new connection requests may not be processed by the failed control plane. In this case the management plane can be used to respond to new connection requests.

The strength of the ASON concept lies in the fact that it employs well-developed concepts of the IP world, such as automatic discovery and routing, and allows reuse of some of its protocols, in the circuit switched environment of optical networks. It should be noted, however, that, along with ASON, there exist alternative approaches to the implementation of the control plane for optical networks, such as those based on Generalized Multi-Protocol Label Switching (GMPLS). A good comparison of the two approaches, i.e., ASON and GMPLS, is presented in [45]. We can note that although ASON is a protocol-neutral framework,

there is a high probability that it will be implemented using protocols from the GMPLS family.

## 6. Conclusion

The recent success of optical networking is due to advances in both optical and electronic technologies. The enormous increase of bandwidth offered by a single-wavelength multiplexed fiber would not be possible without new kinds of lasers and other kinds of optical devices. At the same time, the majority of client signals have roots in digital time division systems of either fixed or packet-oriented framing structure, quite often poorly matching large capacity optical “pipes”. The solution is to smartly combine the strengths of optics and electronics by using the appropriate technology where it fits the best. An example of such a combination is grooming of low speed signals in the electrical domain and then transporting them over long distances in optical fibers. The same is also true at the element level. Optical switches offering vast transmission bandwidth are most efficiently controlled by electronic circuitry. Overall control and management of optical transport networks is also mostly done in the electrical domain. Even multi-layer optical networks, as shown in this paper, contain layer networks of varying degrees of optical technology penetration.

The enormous bit rates of signals carried by optical networks trigger the need for high reliability. Numerous protection and restoration schemes have been developed to increase the resilience of optical networks. Descriptions of such schemes can be found, for example, in [2,46,47].

Although we have concentrated on core and metropolitan area transport networks, the access area is also a good example of coexistence of different technologies, although for somewhat different reasons. Because of a large existing base, copper-based electrical solutions still dominate fixed access networks. But fiber proliferation is growing also in this area [48–50]. Mobility needs resulted in an unprecedented growth of wireless solutions based on electronic technology.

Although, throughout this paper, the strengths of electronics were often presented, we have to remember that without the optical technology the unprecedented development of networking and network services, including those related to the Internet, would not be possible.

## References

- [1] D.K. Mynbaev, L.L. Scheiner, *Fiber-Optic Communications Technology*, Prentice Hall, Upper Saddle River, 2001.
- [2] R. Ramaswami, K.N. Sivarajan, *Optical Networks: A Practical Perspective*, Morgan Kaufmann, San Francisco, 2002.
- [3] S.V. Kartalopoulos, *DWDM: Networks, Devices, and Technology*, Wiley, Hoboken, 2003.
- [4] ITU-T Recommendation G.8080/Y.1304, *Architecture for the Automatically Switched Optical Networks*, November 2001, and Amendment 1, March 2003.
- [5] G. Bernstein, B. Rajagopalan, D. Saha, *Optical Network Control: Architecture, Protocols, and Standards*, Addison-Wesley, Boston, 2004.
- [6] B. Rajagopalan, et al. *IP over Optical Networks: A Framework*, Internet Draft, 2002, work in progress.
- [7] D. Colle et al., *Developing control plane models for optical networks*, in: *Technical Digest, 2002 Optical Fiber Communication Conference OFC 2002*, Anaheim, CA, March 17–22, 2002, pp. 757–759.
- [8] A. Rodriguez-Moral, P. Bonenfant, M. Krishnaswamy, *The optical Internet: architectures and protocols for the global infrastructure of tomorrow*, *IEEE Commun. Mag.* 39 (7) (2001) 152–159.
- [9] S.S. Dixit (Ed.), *IP over WDM: Building the Next Generation Optical Internet*, Wiley, Hoboken, 2003.
- [10] G. Ellinas et al., *Network control and management challenges in opaque networks utilizing transparent optical switches*, *IEEE Commun. Mag.* 42 (2) (2004) S16–S24.
- [11] R. Dutta, G.N. Rouskas, *Traffic grooming in WDM networks: past and future*, *IEEE Network* 16 (6) (2002) 46–56.
- [12] K. Zhu, B. Mukherjee, *A review of traffic grooming in WDM optical networks: architectures and challenges*, *Optical Networks Mag.* 4 (2) (2003) 55–64.
- [13] T.S. El-Bawab et al., *The evolution to optical-switching-based core networks*, *Optical Networks Mag.* 4 (2) (2003) 7–19.
- [14] T.Y. Chai et al., *Design and performance of optical cross-connect architectures with converter sharing*, *Optical Networks Mag.* 3 (4) (2002) 73–84.
- [15] S.V. Kartalopoulos, *Next Generation SONET/SDH: Voice and Data*, Wiley, Hoboken, 2004.
- [16] A. Jajszczyk, *Photonic switching*, in: F.E. Froehlich (Ed.), *Encyclopedia of Telecommunications*, vol. 14, Marcel Dekker, New York, 1997, pp. 355–385.
- [17] A. Neukermans, R. Ramaswami, *MEMS technology for optical networking applications*, *IEEE Commun. Mag.* 39 (1) (2001) 62–69.
- [18] K.H. Liu, *IP over WDM*, Wiley, Hoboken, 2002.
- [19] A. Ware, *New photonic switching technology for all-optical networks*, *Lightwave* (2000).
- [20] M.J. Potasek, *All-optical switching for high bandwidth optical networks*, *Optical Networks Mag.* 3 (6) (2002) 30–43.
- [21] P. Perrier, *Optical cross-connects—Part 2: enabling technologies*, *Fiber Optics Online*, September 1, 2000, <http://www.fiberopticsonline.com>.
- [22] Y. Lee, B. Mukherjee, *Traffic engineering in next-generation optical networks*, *IEEE Commun. Surveys Tutorials* 6 (3) (2004) 16–33 (third quarter).

- [23] G.M. Tosi-Beleffi, et al. 3R all optical regeneration, in: Proc. 6th Int. Conference on Transparent Optical Networks ICTON 2004, July 4–8, 2004, Wroclaw, Poland, vol. 2, pp. 55–58.
- [24] B. Mukherjee, *Optical Communication Networks*, McGraw-Hill, New York, 1997.
- [25] G. Kovacs, E. Udvary, T. Bercei, Semiconductor optical amplifiers for all-optical wavelength conversion, in: Proc. 6th Int. Conference on Transparent Optical Networks ICTON 2004, July 4–8, 2004, Wroclaw, Poland, vol. 2, pp. 37–40.
- [26] Draft new ITU-T recommendation G.697, *Optical Monitoring for DWDM Systems*, 2004.
- [27] ITU-T Recommendation G.872, *Architecture of Optical Transport Networks*, November 2001.
- [28] ITU-T Recommendation G.709/Y.1331, *Interfaces for the Optical Transport Network (OTN)*, March 2003.
- [29] Y. Chen, C. Qiao, X. Yu, Optical burst switching: a new area in optical networking research, *IEEE Network* 18 (3) (2004) 16–23.
- [30] P. Zhou, O. Yang, How practical is optical packet switching in core networks, in: Proc. IEEE Globecom 2003, 2003, pp. 2709–2713.
- [31] P.R. Prucnal, P.A. Perrier, Optically-processed routing for fast packet switching, *IEEE Lightwave Commun. Sys.* 1 (1990) 54–67.
- [32] D.J. Blumenthal, P.R. Prucnal, J.R. Sauer, Photonic packet switches: architectures and experimental implementations, *Proc. IEEE* 82 (1994) 1650–1667.
- [33] A. Jajszczyk, H.T. Mouftah, Photonic fast packet switching, *IEEE Commun. Mag.* 31 (2) (1993) 58–65.
- [34] ITU-T Recommendation G.7041/Y.1303, *Generic Framing Procedure*, December 2003.
- [35] E. Hernandez-Valencia, M. Scholten, Z. Zhu, The Generic framing procedure (GFP): An overview, *IEEE Commun. Mag.* 40 (5) (2002) 63–71.
- [36] IEEE Draft P802.17/D3.3, *Resilient Packet Ring (RPR) Access Method & Physical Layer Specifications*, 2004.
- [37] ITU-T Recommendation X.87/Y.1324, *Multiple Services Ring Based on RPR*, October 2003.
- [38] *Metro Ethernet networks—a technical overview*, Metro Ethernet Forum, 2004.
- [39] IEEE Standard 802.3-2002, *Carrier Sense Multiple Access with Collision Detection (CSMA/CD) Access Method and Physical Layer Specifications*, March 2002.
- [40] R. Santitiro, *Metro Ethernet services—a technical overview*, Metro Ethernet Forum, 2003.
- [41] A. Jajszczyk, Control plane for optical networks: The ASON approach, *China Commun. Mag.* 1 (1) (2004).
- [42] ITU-T Recommendation G.7713.1/Y.1704.1, *Distributed Call and Connection Management (DCM) based on PNNI*, March 2003.
- [43] ITU-T Recommendation G.7713.2/Y.1704.2, *DCM Signalling Mechanism Using GMPLS RSVP-TE*, March 2003.
- [44] ITU-T Recommendation G.7713.3/Y.1704.3, *Distributed Call and Connection Management using GMPLS CR-LDP*, March 2003.
- [45] S. Tomic et al., ASON and GMPLS—overview and comparison, *Photonic Network Commun.* 7 (2) (2004) 111–130.
- [46] W.D. Grover, *Mesh-Based Survivable Networks: Options and Strategies for Optical, MPLS, SONET, and ATM Networking*, Prentice Hall, Upper Saddle River, NJ, 2003.
- [47] J.-P. Vasseur, M. Pickavet, P. Demeester, *Network Recovery: Protection and Restoration of Optical, SONET-SDH, IP, and MPLS*, Morgan Kaufmann, Los Altos, CA, 2004.
- [48] I. Chlamtac, J.P. Jue, Optical WDM networks: future vision, in: K.M. Sivalingam, S. Subramaniam (Eds.), *Optical WDM Networks: Principles and Practice*, Kluwer Academic Publishers, Boston, 2000.
- [49] N.J. Frigo, P.P. Iannone, K.C. Reichmann, A view of fiber to the home economics, *IEEE Optical Commun.* 2 (3) (2004) S16–S23.
- [50] Y.-L. Hsueh et al., Success-DWA: a highly scalable and cost-effective optical access network, *IEEE Optical Commun.* 2 (3) (2004) S24–S30.