

Quick Start Guide for the Agilent 33220A Waveform Generator

Prepared by:
John B. Helder
Georgia Institute of Technology
Fall 2005







Table of Contents

1.	INTRODUCTION	1
2.	DEFINITIONS	1
3.	GETTING STARTED	2
3.1.	TURNING THE UNIT ON.....	2
3.2.	USING THE BUILT-IN HELP SYSTEM	2
3.3.	ENTERING NUMERIC VALUES	3
3.3.1.	<i>Direct Input via the Keypad</i>	3
3.3.2.	<i>Relative Input via the Knob and Arrows</i>	4
3.4.	SETTING THE OUTPUT FREQUENCY OR PERIOD.....	4
3.5.	SETTING THE OUTPUT AMPLITUDE	5
3.5.1.	<i>Via Amplitude and the DC Component</i>	5
3.5.2.	<i>Via Maximum and Minimum Values</i>	5
3.6.	SETTING THE LOAD IMPEDANCE	6
4.	FUNCTION SETTINGS	6
4.1.	SINE WAVE.....	6
4.2.	SQUARE WAVE.....	7
4.3.	TRIANGLE/RAMP WAVE	7
4.4.	PULSE	8
4.5.	NOISE.....	8
4.6.	BUILT-IN ARBITRARY WAVEFORMS	8
5.	ADDITIONAL FEATURES	9
5.1.	AMPLITUDE & FREQUENCY MODULATION	9
5.2.	SWEEP.....	10
5.3.	BURST.....	11
6.	USER DEFINED ARBITRARY WAVEFORMS	11
6.1.	SAVING A WAVEFORM FROM MATHSOFT MATHCAD	12
6.2.	TRANSFERRING A WAVEFORM.....	13
7.	TECHNICAL SPECIFICATIONS	15
8.	TROUBLESHOOTING	15
	APPENDIX A: EXAMPLE MATHSOFT MATHCAD FILE TO GENERATE A WAVEFORM	A1

1. Introduction

The Agilent 33220A Function and Waveform Generator is part of the next generation of signal generators, replacing the previous 33120A series. Its ease of use, coupled with advanced waveform features, provides a balance suitable for both the novice and expert. Standard waveforms include sine waves, square wave, ramp waves, pulses, and Gaussian noise. When used in conjunction with Mathsoft's MathCAD and Agilent's IntuiLink software, 14-bit per sample custom waveforms may be transferred from the computer to the waveform generator, resulting in endless possible waveform designs. Additional features include amplitude and frequency modulation, frequency sweeps, and bursts, which provide advanced users the flexibility to combine existing waveforms as necessary.

2. Definitions

Dynamic Button	The buttons immediately beneath the display on the front of the waveform generator. The functionality assigned to these buttons is presented on the display immediately above the button, and the meaning changes depending on the current state of the device.
Frequency	The number of time a waveform repeats in one second. It is equal to $\frac{1}{\text{Period}}$.
Period	The length of time it takes before a waveform begins to repeat itself. It is equal to $\frac{1}{\text{frequency}}$.
Sine Wave	 A waveform consisting of a single frequency.
Square Wave	 A waveform consisting of alternating constant amplitudes.
Triangle Wave	 A ramp wave with symmetry equal to 50 percent.
Ramp Wave	 A waveform with a linear slope. When the symmetry of a ramp wave is either 0 or 100 percent, the waveform may also be referred to as a sawtooth wave.
Pulse	 A waveform with finite rise and fall times and is similar to a square wave. Sometimes referred to as a Pulse Train.
Noise	 A waveform with random amplitude. The randomness of the output for the Agilent 33220A is a Gaussian distribution.
Amplitude Modulation	A modulation technique in which a waveform is created by multiplying a carrier and modulator waveform.
Frequency Modulation	A modulation technique in which the frequency of a carrier wave is modified based on the frequency of a modulator.
Burst	A short output of a waveform a number of times, followed by a period of no signal.
Sweep	A smooth continuous increase or decrease between two frequencies. The rate may be either a linear or logarithmic function.

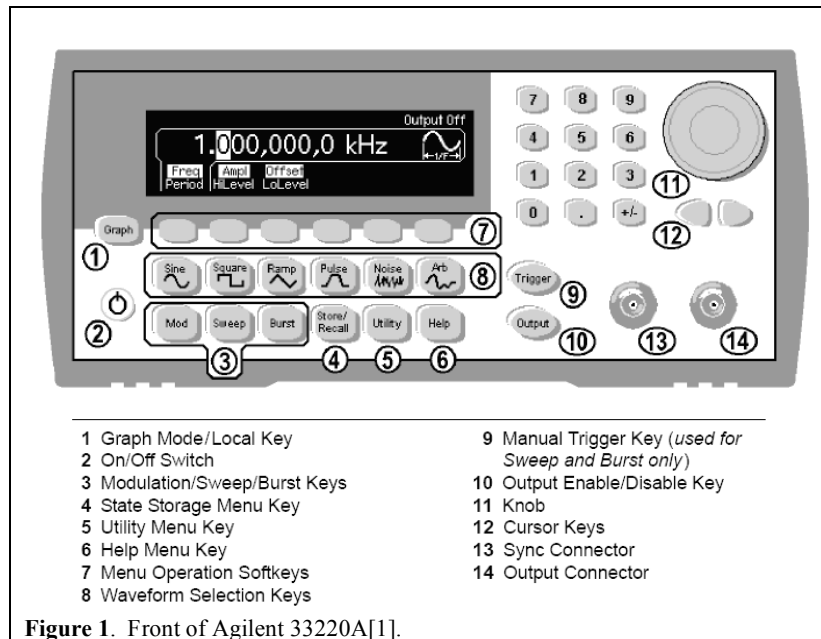

3. Getting Started

The 33220A will be controlled through the front panel presented in Figure 1.



3.1. Turning the Unit On

Unlike previous generation function generators, the power switch is now a momentary push-button instead of a physical switch. This difference will not impact its use however.

1. Press the  button (marked 2 in Figure 1, above). The button will glow green when the unit has been successfully turned on.
2. If the  button (marked 10 in Figure 1) is not green, then press  for the waveform to be passed to the output connector, which is labeled 14 in Figure 1.

3.2. Using the Built-In Help System

In addition to pressing the  button for general information, additional information is available through one of the alternate method listed in Table 1.

[1] “Agilent 33220A 20MHz / Arbitrary Function Waveform Generator User’s Guide,” [Online Document], 2005 March 3, [2005 September 4], Available HTTP: <http://www.home.agilent.com/USeng/nav/-11457.536883183/pd.html>

Method	Description
Press and hold the function button.	Information about the function.
Press and hold a dynamic button (beneath the display).	Information about the dynamic button's currently defined function.
Press the  button when an error has occurred.	Select the topic "View the last message displayed" to see a more detailed description about the error.

3.3. Entering Numeric Values

Two methods are available to the user to change the frequency or period of the output: direct input through the keypad (shown in Figure 2) and relative input through the knob (shown in Figure 3).

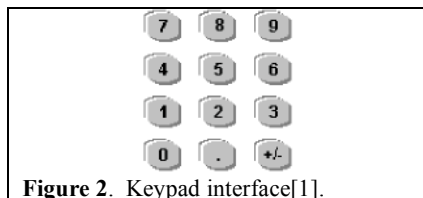

Figure 2. Keypad interface[1].

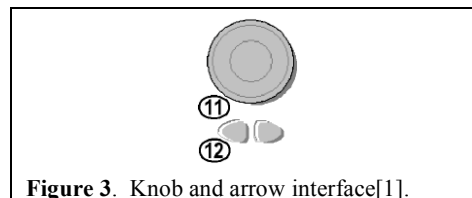

Figure 3. Knob and arrow interface[1].

3.3.1. Direct Input via the Keypad

1. Press the dynamic button beneath the display until the desired parameter is selected. Selection is denoted by black text on a white background as depicted in Figure 4.

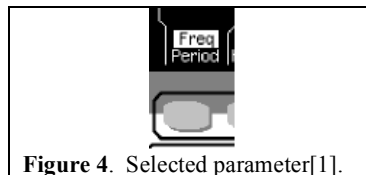

Figure 4. Selected parameter[1].

2. Enter the numeric value via the keypad (Figure 2 above). Select the appropriate unit depending on the definition method by pressing the dynamic button beneath the display as presented in Figure 5.

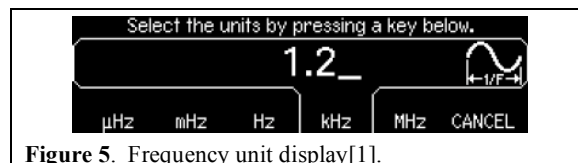

Figure 5. Frequency unit display[1].

3. The output of the Agilent 33220A will immediately update to reflect the change.

3.3.2. Relative Input via the Knob and Arrows

1. Press the dynamic button beneath the display until the desired definition method is selected. Selection is denoted by black text on a white background as depicted in Figure 6.

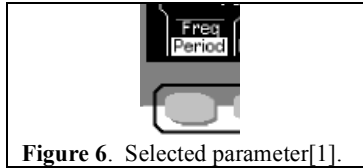

Figure 6. Selected parameter[1].

2. Select the digit to alter by using the arrow buttons (marked 12 in Figure 7). The selected digit will be displayed as a black number on a white background as in Figure 8.

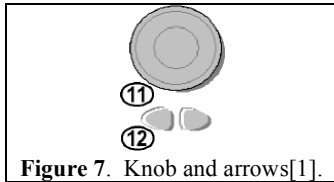

Figure 7. Knob and arrows[1].

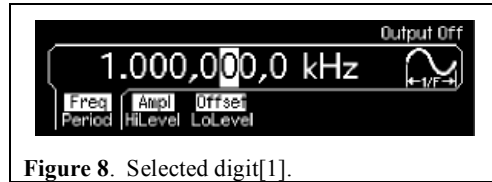

Figure 8. Selected digit[1].

3. Change the selected digit by rotating the knob (marked 11 in Figure 6) clockwise to increase, or counterclockwise to decrease (as shown in Figure 9). The output of the Agilent 33220A will change immediately.

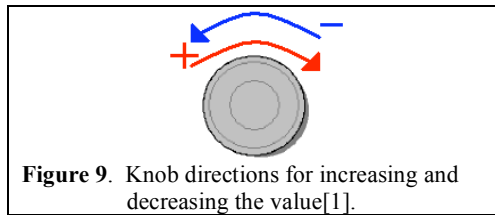



Figure 9. Knob directions for increasing and decreasing the value[1].

3.4. Setting the Output Frequency or Period

The range of valid frequencies and periods for each type of waveform is presented in Table 2.

Waveform	Frequency	Period
Sine	1uHz □ 20 MHz	50 ns □ 1x10 ⁶ s
Square	1uHz □ 20 MHz	50 ns □ 1x10 ⁶ s
Ramp	1uHz □ 200 kHz	50 ns □ 5 us
Triangle	1uHz □ 200 kHz	50 ns □ 5 us
Pulse	500uHz □ 5 MHz	200 ns □ 2000 s
Noise	(9MHz Bandwidth)	<Not Applicable>
Arbitrary	1uHz □ 6 MHz	166.667 ns □ 1x10 ⁶ s

1. Press the desired waveform button to display its modifiable parameters.
2. Press  until the desired parameter is selected. Selection is denoted by black text on a white background.
3. Enter the numeric value. The output of the waveform generator will update immediately.

3.5. Setting the Output Amplitude

The output voltage of the waveform may be entered via one of two methods: amplitude, or maximum and minimum values.

The amplitude displayed on the Agilent 33220A is dependent on the load impedance. Please see Section 3.4 for details on how to set this value. Valid voltage ranges for the function generator are presented in Table 3.

Table 3. Valid Ranges of Amplitude

Impedance Type	Voltage Range
Load (50 Ohms)	10 mV _{pp} □ 10 V _{pp}
High-Z	20 mV _{pp} □ 20 V _{pp}

3.5.1. Via Amplitude and the DC Component

1. Press the **Ampl** / **HiLevel** dynamic button beneath the display until the amplitude selection is highlighted. The selection is denoted by black text on a white background.
2. Enter the numeric value. However, if the relative input method is used via the knob and arrow buttons and the amplitude is to be defined in different units (i.e. V_{RMS} instead of V_{pp}), then press **+L** to bring up the list of possible amplitude units (shown in Figure 10). Press the dynamic button beneath the display corresponding to the desired unit to select. The output of the function generator will change immediately.

Note: If the output impedance is currently set to High-Z and dBm (a unit of power) is selected, the amplitude is automatically converted to V_{pp}.

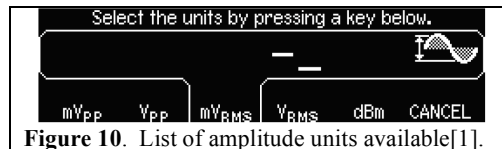

Figure 10. List of amplitude units available[1].

3. To change the DC voltage of the output, select the **Offset** / **LoLevel** dynamic button beneath the display until the offset selection is highlighted.
4. Enter the numeric value and, if necessary, the units. The output of the waveform generator will update immediately.

3.5.2. Via Maximum and Minimum Values



Note: The waveform will not become distorted via this method if the minimum voltage is not the inverse of the maximum. The output of the Agilent 33220A will remain symmetrical but will be shifted by a DC value.

1. Press the **Ampl** / **HiLevel** dynamic button beneath the display until the HiLevel selection is highlighted. The Offset will change to LoLevel automatically. The selection is denoted by black text on a white background.
2. Enter the numeric value and unit for the maximum value of the waveform. The output will update immediately.
3. Press the **Offset** / **LoLevel** dynamic button beneath the display. (LoLevel should already be highlighted.)

4. Enter the numeric value and unit for the minimum value of the waveform. The output will update immediately.

3.6. Setting the Load Impedance

Changing the impedance on the Agilent 33220A does not physically alter the output, which is physically 50 Ohms and cannot be changed. This method will alter the amplitude display to reflect the voltage across the output with the specified load impedance. A numeric value or open circuit may be selected.

1. Press the  button.
2. Press the dynamic buttons labeled Output Setup. The selection is denoted by black text on a white background.
3. Press the dynamic button labeled .
4. For numeric values, use the knob and arrows or keypad to enter the load impedance. To select High-Z as the load impedance, press the dynamic button labeled  as shown in Figure 11. Selection is denoted by black text on a white background.

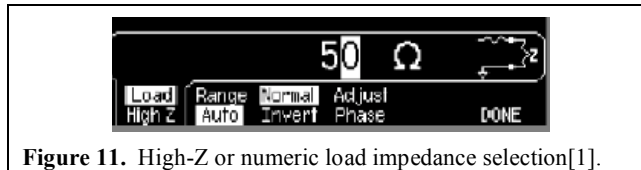

5. Press the dynamic button  when the desired load impedance has been entered.

4. Function Settings

The Agilent 33220A can generate six different categories of waveforms presented in Figure 12. To select a waveform category, press the appropriate button on the front of the waveform generator. Please see Sections 3.4-5 for reference to specify frequency and amplitude.

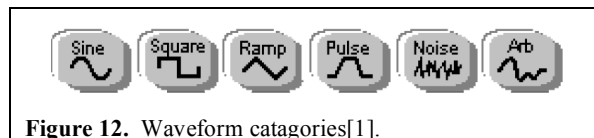

4.1. Sine Wave

To select the sine wave function, press the  button. The modifiable parameters are presented in Table 4.

Table 4. Available Parameters for the Sine Function

Parameter	Range
Frequency	1uHz □ 20 MHz
Amplitude	20 mV _{pp} □ 20 V _{pp}

4.2. Square Wave



To select the square wave function, press the  button. The modifiable parameters are presented in Table 5.

Table 5. Available Parameters for the Square Function

Parameter	Range
Frequency	1uHz □ 20 MHz
Amplitude	20 mV _{pp} □ 20 V _{pp}
Duty cycle	20% □ 80% (0 □ 10 MHz) 40% □ 60% (10 □ 20 MHz)

To specify the duty cycle of the square wave, please follow these directions.

1. Select the  dynamic button to bring up the display shown in Figure 13.

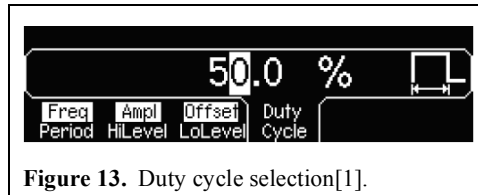

2. Enter the numeric value via the keypad or knob and arrows. Please see Table 5 (above) for the valid input ranges. Once entered, the output will update immediately.

4.3. Triangle/Ramp Wave

Note: A triangle wave is a ramp wave with 50 percent symmetry.

To select the triangle/ramp wave function, press the  button. The modifiable parameters are presented in Table 6.

Table 6. Available Parameters for the Triangle/Ramp Function

Parameter	Range
Frequency	1uHz □ 200 kHz
Amplitude	20 mV _{pp} □ 20 V _{pp}
Symmetry	0% □ 100%

To specify the duty cycle of the square wave, please follow these directions.

1. Press the Symmetry dynamic button.
2. Enter the numeric value via the keypad or knob and arrows. Please see Figure 14 for a picture of the waveform when the symmetry setting is at the extremes. Once entered, the output will update immediately.

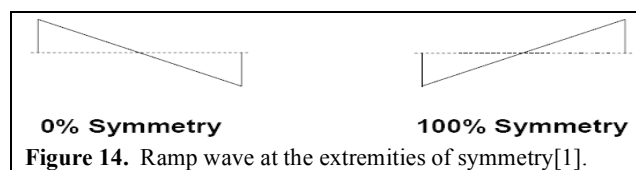

4.4. Pulse

To select the pulse wave function, press the  button. The modifiable parameters are presented in Table 7.

Parameter	Range
Frequency	500 uHz □ 5 MHz
Period	200 ns □ 2000 s
Amplitude	20 mV _{pp} □ 20 V _{pp}
Minimum Width	20 ns for Period < 10 s 200 ns for 10 s < Period < 100 s 2 us for 100 < Period < 1000 s 20 us for Period > 1000s
Rise/Fall Time	Minimum: 20ns Resolution: 10ns

To specify the width of the pulse wave, please follow these directions.

1. Press the  dynamic button.
2. Enter the numeric value via the keypad or knob and arrows. Once entered, the output will update immediately.

To specify the rise and fall time of the pulse wave, please follow these directions.

1. Press the  dynamic button.
2. Enter the numeric value via the keypad or knob and arrows. Once entered, the output will update immediately.

4.5. Noise

To select the Gaussian noise function, press the  button. The modifiable parameters are presented in Table 8.

Parameter	Range
Amplitude	20 mV _{pp} □ 20 V _{pp}

4.6. Built-In Arbitrary Waveforms

To select an internal arbitrary waveform function, press the  button. The modifiable parameters are presented in Table 9.

Note: For user-defined arbitrary waveforms, please see Section 6.

Table 9. Available Parameters for Arbitrary Functions

Parameter	Range
Frequency	1 uHz □ 6 MHz
Amplitude	20 mV _{pp} □ 20 V _{pp}
Available Waveforms	Exponential Rise Exponential Fall Negative Ramp Sinc Cardiac

1. To select a waveform, press the dynamic button labeled Select Wform for internal waveforms, Stored Wform for user-defined saved waveforms, or VOLATILE for the current waveform in volatile memory.
2. Select the waveform by pressing the appropriate dynamic button beneath the display. The five internal waveforms are shown in Figure 15. Once a waveform is selected, the output will update immediately.

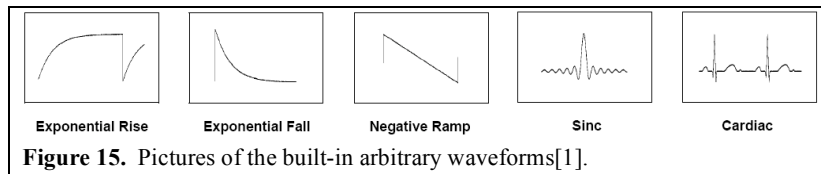

5. Additional Features

The Agilent 33220A can generate six different categories of waveforms. To select a waveform category, press the appropriate button on the front of the waveform generator shown in Figure 16.

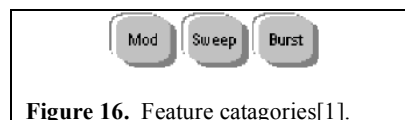

5.1. Amplitude & Frequency Modulation

1. Select the carrier waveform, frequency, and amplitude by pressing the Sine, Square, Ramp, or Arbitrary waveform button. (For descriptions of each waveform, please see Section 4). The carrier may be changed later without turning off the modulation if necessary.
2. Press  to bring up the screen presented in Figure 17.

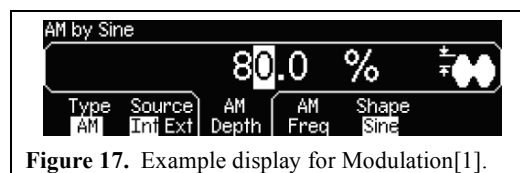

3. Press the **Type** dynamic button to select Amplitude (AM) or Frequency (FM) Modulation. The selected modulation type will appear on the display beneath **Type**.

- Enter the modulating depth of the modulator. A value of 0 percent corresponds to no modulation, while a value of 100 percent is complete modulation.
- Enter the frequency of the modulating waveform by pressing **AM Freq** or **FM Freq**. The modulating frequency may be from 2mHz to 20kHz.
- Select the shape of the modulating waveform by pressing the **Shape** dynamic button.

Note: For arbitrary waveforms, the sampling resolution is reduced to 4096 samples per period.

- If the modulation type is FM, then it is possible to set the maximum Frequency Deviation, which is the maximum frequency shift from the center frequency. The sum of this value plus the carrier frequency (from step 1) must be less than the maximum frequency for the carrier waveform (see Section 4 for details) plus 100 kHz.

5.2. Sweep

- Select the carrier waveform, frequency, and amplitude by pressing the Sine, Square, Ramp, or Arbitrary waveform button. (For descriptions of each waveform, please see Section 4). The carrier may be changed later without turning off the modulation if necessary.
- Press **Sweep** to bring up the screen presented in Figure 18.

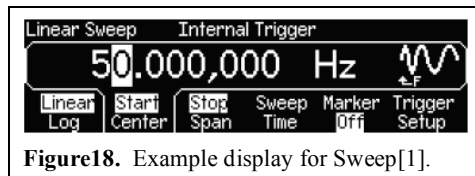

- Press the dynamic button beneath **Linear Log** to choose between a linear and logarithmic sweep mode.
- Enter the beginning and ending frequencies of the sweep either by specifying the start and stop frequencies, or by entering the center frequency and span.

Note: To specify a negative sweep rate (i.e. have the frequency decrease) enter the stop frequency below the start frequency, or enter a negative span.

- Enter the time for each sweep period by pressing the **Sweep Time** dynamic button.
- Select the Trigger mode by pressing the **Trigger Setup** dynamic button. Table 10 describes the three different trigger modes.

Mode	Description
Internal	The sweep frequency automatically resets when the end frequency is reached.
External	A trigger source connected to the rear of the Agilent 33220A controls when the sweep occurs.
Manual	A single sweep only occurs when the  button is pressed.

5.3. Burst

1. Select the carrier waveform, frequency, and amplitude by pressing the appropriate waveform button. (For descriptions of each waveform, please see Section 4). The carrier may be changed later without turning off the modulation if necessary.

Note: Burst noise is only valid in conjunction with the Gated Burst Mode and requires an external gate source.

Note: Except for Infinite Bursting, Square waves and Sine waves are limited to a maximum frequency of 6 MHz.

2. Press  to bring up the screen presented in Figure 19.

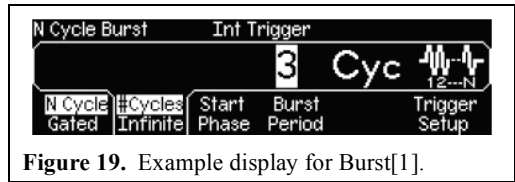

Figure 19. Example display for Burst[1].









3. Press the dynamic button beneath  and select . Selection is denoted by black text on a white background.
4. Press  and enter the number of cycles per burst. For continuous bursting, select .
5. Enter the length of time for each burst period by pressing the  dynamic button.
6. Select the Trigger mode by pressing the  dynamic button. Table 11 describes the three different trigger modes.

Table 11. Available Trigger Modes

Mode	Description
Internal	The burst automatically resets when the end frequency is reached.
External	A trigger source connected to the rear of the Agilent 33220A controls when the sweep occurs.
Manual	A single sweep only occurs when the  button is pressed.

7. Press  to begin or end the burst sequence.

6. User Defined Arbitrary Waveforms

By defining custom waveforms, the Agilent 33220A allows advanced waveform not otherwise available from other common waveform generators.

6.1. Saving a waveform from Mathsoft MathCAD

1. Create a Mathsoft MathCAD file using discrete values for a length of one period. For an example, see Appendix A: Example Mathsoft MathCAD File to Generate a Waveform.

Note: The Agilent 33220A supports from 1 to 65536 discrete points. However, the 33220A will interpolate the transferred points to achieve a length of 16384 or 65536 points, whichever is greater than the length of the transferred waveform.

Note: All values outside the range of $[-1, 1]$ will be clipped to ± 1 when transferred to the Agilent 33220A.

2. Right click on the output table and select Export from the menu. The correct menu item is highlighted in blue in Figure 20.

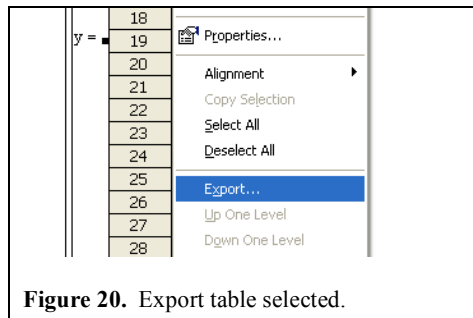

Figure 20. Export table selected.

3. Save the file as type “Comma Separated Values” with “Use comma as decimal symbol” deselected. Figure 21 displays the proper options.

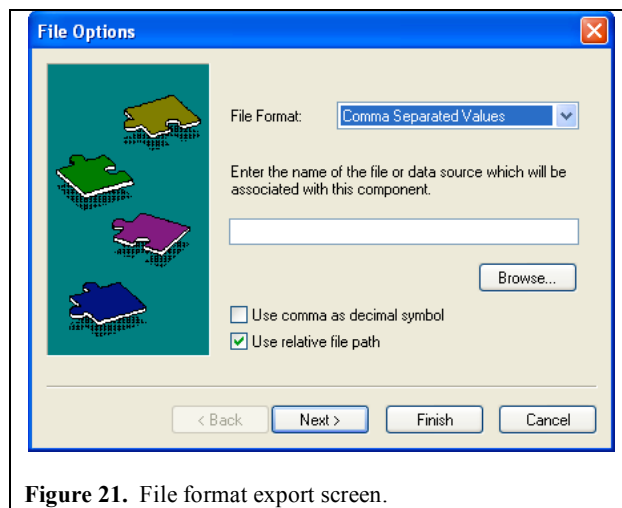

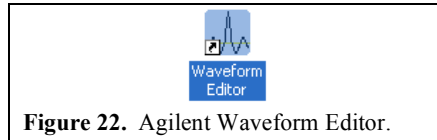



Figure 21. File format export screen.

4. Select the desired data range to save to the file. It is recommended both Row and Column begin at 1 and stop at the end of data.
5. Click  to complete the export process.

6.2. Transferring a waveform

1. Turn on the Agilent 33220A. For help, please see Section 3.1.
2. Open the Agilent Waveform Editor by double-clicking on the icon. The icon is shown in Figure 22.

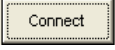

3. If this is the first time running this program, the window shown in Figure 23 will appear. The Agilent 33220A will appear as GPIB0::10::INSTR or GPIB0::10::INSTR depending on the workstation. If the instruments are not automatically identified, select the address in the left column and press . The correct instrument will identify itself with an instrument type of **Arb**. Select this entry and press . Close the window.

Note: This window is allow available from the Connections Menu should changes need to be made.

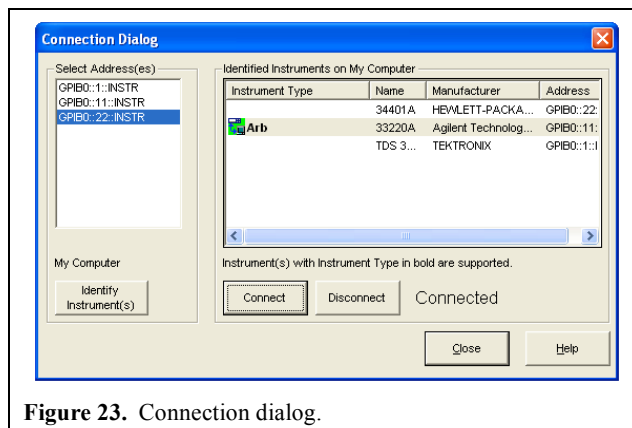
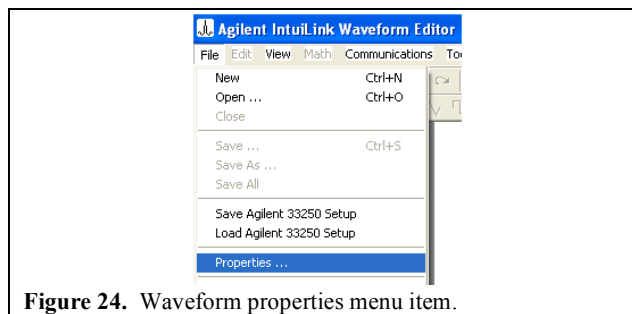

Figure 23. Connection dialog.

4. From the File menu, select Properties as shown in Figure 24.



5. In the resulting window that appears (shown in Figure 25), set Points to either 65536 or 16384 and the Quantization Bits to 14. These settings allow optimum use of the 33220A's resources, although if necessary, other settings are valid.

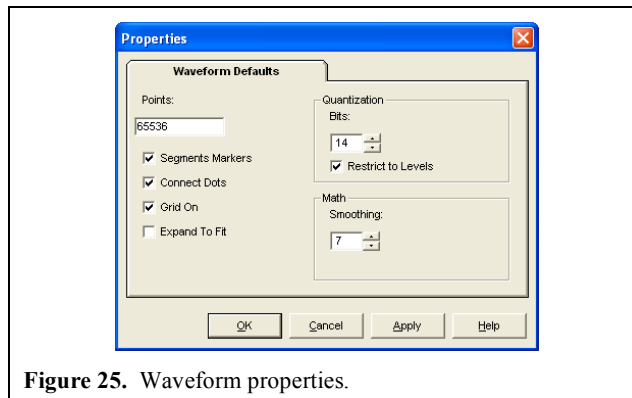

Figure 25. Waveform properties.

6. Open the file containing the waveform data via the File Menu. For information how to create a waveform file to import, please see Section 6.1 or Appendix A.

Note: All values outside the range of [-1, 1] will be clipped to ±1.

7. Open the Send Waveform window from the Communications Menu as shown in Figure 26.

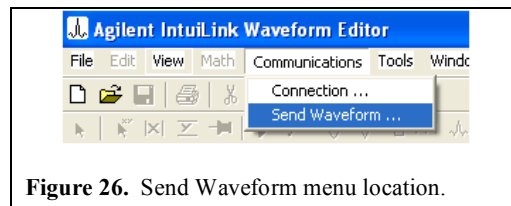

Figure 26. Send Waveform menu location.

8. The resulting window in Figure 27 will allow modification of the waveform parameters. If the waveform is to remain available after the 33220A has been turned off, save the waveform with a Memory Name to store it non-volatile memory, otherwise, save to waveform to Volatile memory.

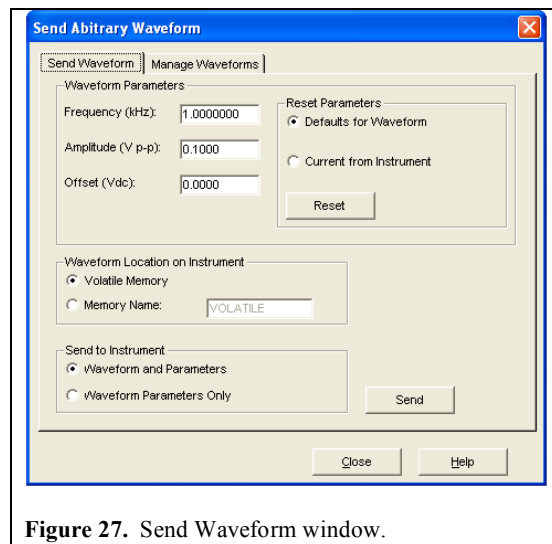



Figure 27. Send Waveform window.

9. Transfer the waveform to the 33220A by clicking . Press OK in the window that appears to begin the transfer.

10. Press  on the 33220A to return control to the front panel of the waveform generator.

7. Technical Specifications

Please visit <http://www.agilent.com/> for detailed specifications.
(Direct link: <http://cp.literature.agilent.com/litweb/pdf/5988-8544EN.pdf>)

8. Troubleshooting

Is there a way to bypass the output resistor? I think it may be adversely affecting my circuit because of the 50 Ohm resistance in series with the output.

Create a Thevenin equivalent based on your requirements by adding a low impedance shunt across the circuit. Depending on the design, it may be necessary to calculate a voltage correction factor to accommodate the possible voltage difference between the output of the 33220A and the output of the added circuitry. Figure 28 presents an example circuit. The resulting output impedance is 19 Ohms with a voltage attenuation of 12.4 dB. However, the attenuation can be corrected via software or by increasing the output amplitude from the 33220A.

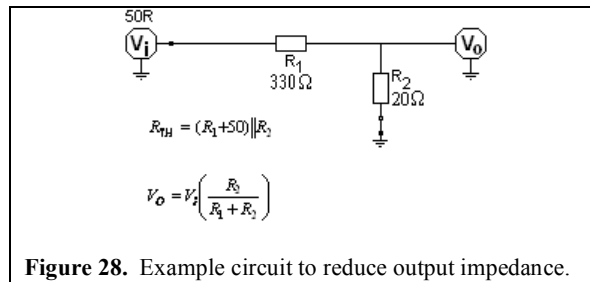

Figure 28. Example circuit to reduce output impedance.

How can I obtain an Amplitude Modulated signal that turns on and off? I am trying to modulate a square wave with another wave to create OOK (On-Off Keying) via Amplitude Modulation, but instead of what I want, my signal appears on the flat regions of the square wave.

There are two possible options to resolve this problem.

1. Change your carrier waveform to the other wave, and the square wave as the AM modulator.
2. Use Burst Modulation instead of Amplitude Modulation to define the On-Off sequence.

The burst mode is easier to define, but has less flexibility because the number of waveform cycles per period must be a whole number. On the other hand, the square wave modulator has an unalterable duty cycle of 50 percent.

How can I create a square wave with a duty cycle of less than 10 percent or greater than 90 percent?

Investigate the possibility of using a Pulse waveform with infinite count instead of a square wave. Depending on your requirements, it may be possible to define a square wave with a duty cycle as small as a fraction of one-percent or as large as nearly 100 percent. Please see Section 4.4 for information on how to define a Pulse waveform.

**Appendix A:
Example Mathsoft MathCAD File to Generate a Waveform**

Step 1. Define the number of points to use. Recommended values are 16384 and 65536.

Points := 64000

Sampling frequency. Do not modify. $f_s := \frac{1}{\text{Points}}$
 Array Index. Do not modify. $i := 0 \dots (\text{Points} - 1)$

Step 2. Define the Discrete Function. Multiple iterations may be necessary to produce values between -1 and 1, inclusive.

$y_i := \sin(2 \cdot \pi \cdot 10 \cdot f_s \cdot i) \cdot \exp(-5 \cdot f_s \cdot i) + (0 - i \cdot f_s)$

Maximum and Minimum Values of the function must be between -1 and 1, inclusive.

max(y) = 0.862
 min(y) = -1

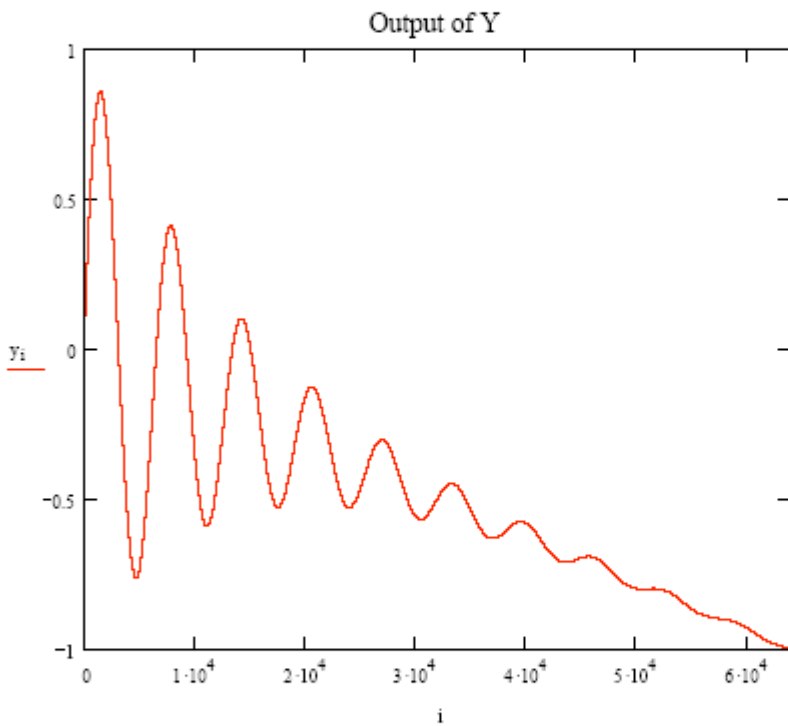

	0
0	0
1	9.66·10 ⁻⁴
2	1.932·10 ⁻³
3	2.898·10 ⁻³
4	3.863·10 ⁻³
5	4.829·10 ⁻³
6	5.794·10 ⁻³
7	6.759·10 ⁻³
8	7.724·10 ⁻³
9	8.689·10 ⁻³
10	9.653·10 ⁻³
11	0.011
12	0.012
13	0.013
14	0.014
15	0.014
16	0.015
17	0.016
18	0.017
19	0.018
20	0.019
21	0.02
22	0.021
23	0.022
24	0.023
25	0.024
26	0.025
27	0.026
28	0.027
29	0.028
30	0.029
31	0.03
32	0.031
33	0.032
34	0.033
35	0.034
36	0.035
37	0.036
38	0.037
39	0.038

To Export the Data:

Export the column to the right by right clicking on it and selecting "Export".

Use the CSV (Comma Separated Values) format to export with "Use comma as decimal symbol" unselected. Click "Next".

Enter the data range desired. For most purposes, start at column 1 and row 1, and stop at the end of data. Click "Finish"